



ABS M5 Kit Porsche Cup

Manual

Content

1 System Overview	4
2 Before Use	5
2.1 Safety Information	5
2.2 ABS in Motorsport	5
2.3 Principle of Operation	6
2.4 Features.....	6
3 Technical Data	9
4 Disposal	11
5 Adaptations to your Vehicle	12
6 Included in the Kit.....	14
6.1 ABS M5 Kit Porsche 991 Cup.....	14
6.2 ABS M5 Kit Porsche 997 Cup.....	14
7 Assembling the Parts	15
7.1 Hydraulic Power Unit with attached Control Unit.....	15
7.2 Brake Pressure Sensor	16
7.3 Wheel Speed Sensors	16
7.4 Encoder Wheel	17
7.5 Distance between the Sensor and the Encoder Wheel	17
7.6 Yaw/Acceleration Sensor.....	17
7.7 Map Switch	18
7.8 Warning Light (MIL).....	18
7.9 Brake Lines	19
7.10 Brake Calipers	20
7.11 Master Cylinders.....	20
7.12 Pressure Medium.....	20
8 Laptop Communication	22
9 Programming and Diagnosis Software.....	23
9.1 Installing the Programming and Diagnosis Software	23
9.2 Features of the Programming and Diagnosis Software	26
10 Startup Checklist	36
11 Legal	38
11.1 Legal Restrictions of Sale	38
12 CAN Protocol V15 customer from 0400 onwards	39
13 Drawings and Diagrams	41
13.1 Offer Drawing Hydraulic Unit.....	41
13.2 Offer Drawing Wheel Speed Sensor	42
13.3 Offer Drawing Brake Pressure Sensor	43
13.4 Mounting Instructions Brake Pressure Sensor.....	44
13.5 Offer Drawing Yaw/Acceleration Sensor 500 kbaud	45
13.6 Offer Drawing Yaw/Acceleration Sensor 1 Mbaud	46
13.7 Wiring Harness Porsche 991 Gen.1	47
13.8 Wiring Harness Porsche 991 Gen.1 Front.....	48

13.9 Wiring Harness Porsche 991 Gen.1 Rear.....	49
13.10 Wiring Harness Porsche 991 Gen.2.....	50
13.11 Wiring Harness Porsche 991 Gen.2 Front.....	51
13.12 Wiring Harness Porsche 991 Gen.2 Rear.....	52

1 System Overview

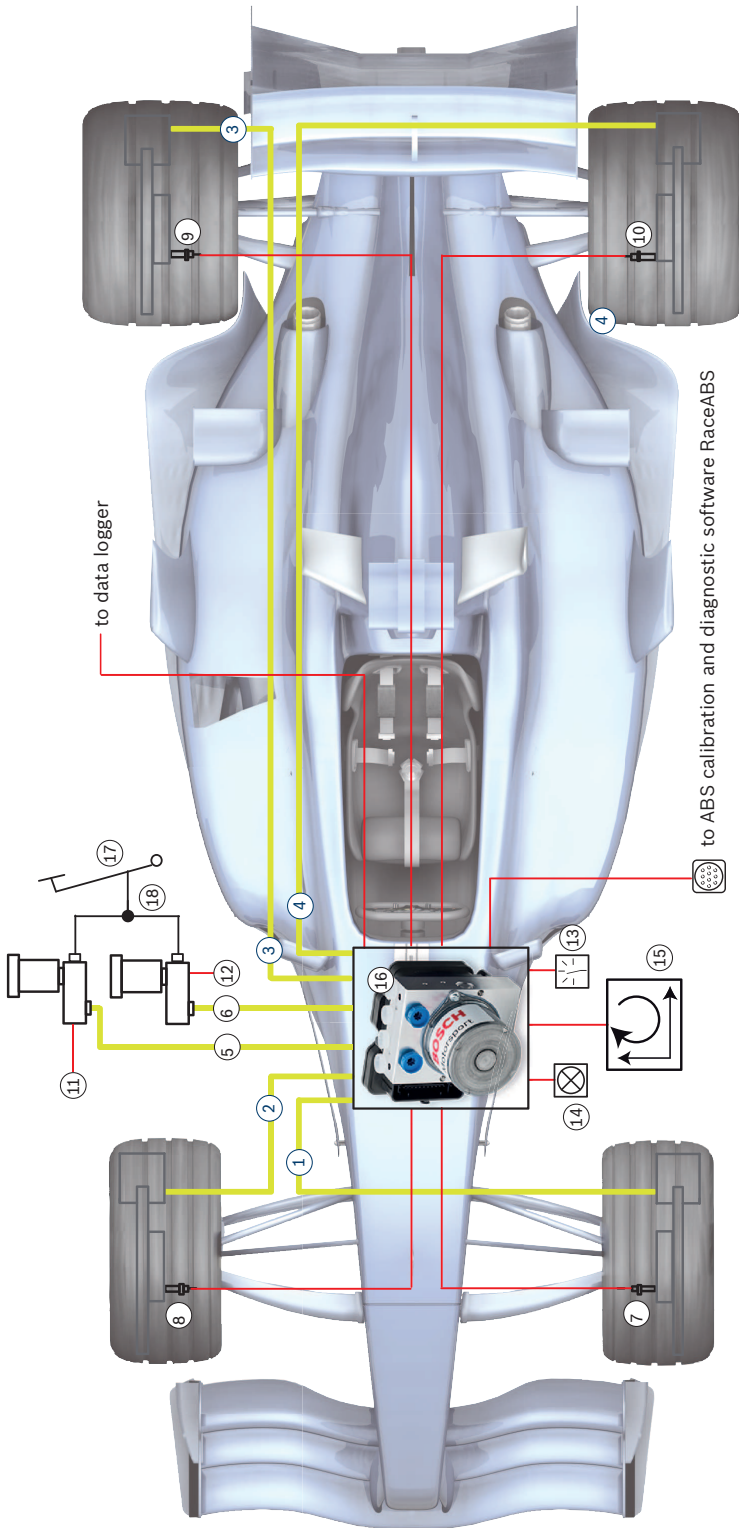

- Brake lines** —
- 1 Brake pressure front left
- 2 Brake pressure front right
- 3 Brake pressure rear right
- 4 Brake pressure rear left
- 5 Brake pressure master cylinder front
- 6 Brake pressure master cylinder rear

- Measuring channels** —
- 7 Wheel speed front left
- 8 Wheel speed front right
- 9 Wheel speed rear right
- 10 Wheel speed rear left
- 11 Signal brake pressure sensor front
- 12 Signal brake pressure sensor rear
- 13 Signal function switch
- 14 ABS Warning Lamp (MIL)
- 15 Yaw / Acceleration signal

- Hardware**
- 16 ABS ECU & hydraulic modulator
- 17 Brake pedal
- 18 Brake balance adjuster

2 Before Use

Read these instructions carefully and follow the recommendations for use step by step. We are happy to give you additional notes and explanations. Our contact information is on the back cover of this manual.

2.1 Safety Information

The ABS M5 Porsche Cup Kit was developed for use by professionals and requires in-depth knowledge of automobile technology and experience in motorsport. Using the system does not come without its risks.

It is the duty of the customer to use the system for motor racing purposes only and not on public roads. We accept no responsibility for the reliability of the system on public roads. In the event that the system is used on public roads, we shall not be held responsible or liable for damages.

Any maintenance or repair must be performed by authorized and qualified personnel approved by Bosch Motorsport.

All system parts are designed to work together and may not be replaced with similar parts without our expressed permission (this includes the wiring harness). For first time purchases, each team or owner must purchase a complete kit which includes a wiring harness. Spare parts may be purchased after a complete kit has been purchased. The use of unauthorized parts or wiring harnesses will not be supported by Bosch Motorsport; additionally the system cannot be guaranteed to work properly and/or without limitations.

It is essential that the predefined Bosch Motorsport assembly guidelines are complied with the system to run properly, see section Assembling the Parts [▶ 15]. This applies above all for installing the MIL (malfunction indication lamp) within the driver's range of visibility.

Safety Concept

Two pressure sensors (one internal, one PWM input) to monitor the system pressure ensure high reliability. Due to the redundant use of the sensors, the system reliability is significantly increased.

If the pump motor fails, a warning is set and the EBS-system is able to perform the next following driver brake request due to the 160 bar pre-filled reservoir.

If there is an EBS failure during the race, a backup mode automatically takes effect. From this moment on, only hydraulic braking takes place. This enables the driver to brake reliably at all times.

2.2 ABS in Motorsport

The ABS function is a compromise between drivability and braking performance. Drivability is the primary focus for passenger based vehicles. The ABS is designed to keep the passenger vehicle maneuverable and stable under any circumstances and under any conceivable driving conditions.

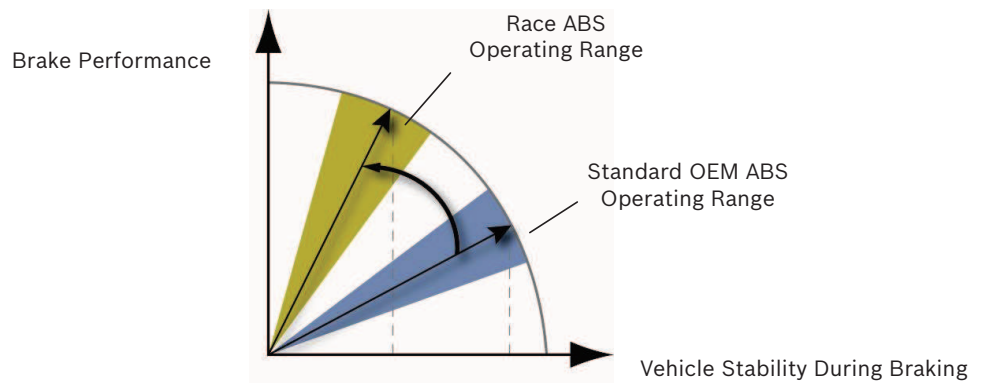

In a motorsport context, this compromise shifts towards braking performance, as experienced drivers can still control a slightly unstable vehicle. Together with different tire structures and higher braking potential, a racecar is capable of greatly increased deceleration rates. To consider different chassis tuning and tires, ABS M5 Porsche Cup Kit has eleven control settings plus an OFF-position. With this, the driver can choose the best setting for his vehicle. For calibration drives, the ABS function can be deactivated separately, whereby all ABS sensor signals are transmitted and processed furthermore (OFF-position of the ABS switch).

2.3 Principle of Operation

ABS M5 Porsche Cup Kit is suitable for **front-wheel, rear-wheel and four-wheel drive vehicles**. It is based on a series production ABS M5 Porsche Cup Kit and adapted in years of development work to meet motorsport requirements, e.g. FIA requirements for using only eight active valves.

The ABS M5 Porsche Cup Kit prevents the wheels from locking during braking. It does this by constantly measuring the individual wheel speeds and comparing them with the vehicle speed predicted by the system. If, during braking, the measured wheel speed deviates from the system's predicted vehicle speed, the ABS M5 Porsche Cup Kit controller takes over, correcting the brake force to keep the wheel at the optimum slip level and so achieving the highest possible deceleration rate. This is carried out separately for each wheel.

When the brake force is reduced by the ABS M5 Porsche Cup Kit, brake fluid is released from the brake caliper and fed into the pressure reservoir of the hydraulic power unit of the ABS M5 Porsche Cup Kit. The hydraulic power unit then feeds the fluid back into the master cylinder via a piston pump driven by an electric motor. The driver can hear this return pumping of the brake fluid and feel the response of the brake pedal.

2.4 Features

Note: In the following, we only refer to the *ABS M5 scale, standard*. You can use the *ABS M5 scale, alternative*, if your ABS M5 Porsche Cup Kit is switched off in position 1.

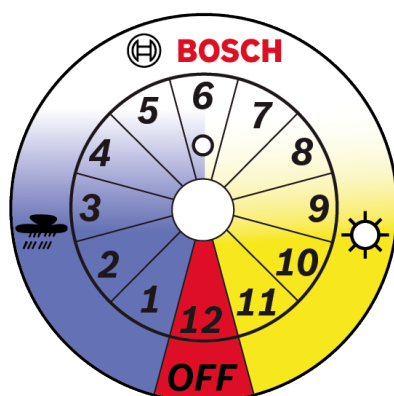

ABS M5 scale, standard

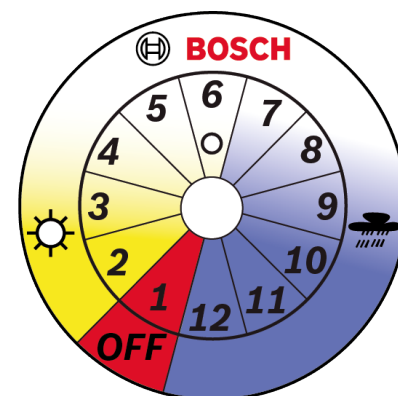

ABS M5 scale, alternative

The ABS M5 has eleven different control settings, selectable via a switch in the cockpit (position 1 to 11 with OFF on position 12 or position 2 to 12 with OFF on position 1). The ABS map switch in the cockpit enables the driver to select various control settings stored in the control device. Using the standard ABS scale, it starts with switch position 1 for the most sensitive controller setting (e.g. heavy rain condition). The configured control settings allow progressively more slip as the position of the dial gets numerically higher. With switch position 11, the most aggressive settings are achieved. Your optimal setting is not necessarily the most aggressive.

- Calibration
 - In case of need, the calibration of the 11 control maps can be done by Bosch Motorsport ABS engineers.
- Switch off ABS functions for calibration drives
 - Switching off the ABS functions can be very helpful, e.g. for adjustment of the brake balance bar. OFF-position will be signaled by lit MIL (Malfunction Indication Lamp). All ABS sensor signals will still be communicated. ABS should be turned off in any case where the drive wheels are spinning while the car is stationary, e.g. during warm-up or when on the dynamometer. No error entry will take place.
- Measuring vehicle dynamics
 - Due to specially-adapted chassis and tires, racing vehicles allow for significantly higher longitudinal and lateral acceleration rates than series production vehicles. Our ABS M5 Porsche Cup Kit sensors constantly measure vehicle acceleration and lateral forces as well as the pressure of the front and rear brake circuit.
- Programming and diagnosis software
 - Each ABS M5 Porsche Cup Kit can be configured with specific data related to the vehicle, such as vehicle mass, wheelbase, track width, tire rolling circumference, etc. Should the vehicle data change at any time, you can adapt the system settings by using the RaceABS diagnostic software. You find the software for free download on our website www.bosch-motorsport.com. The new RaceABS diagnostic tool will also work with older ABS M4 systems.
- Performing a system function test
 - The system function test can diagnose the functional capability without having to move the vehicle.
- Reading data from the error log
 - Any missing part or incorrectly connected electrical connection of ABS operation-critical components are signaled by a lit MIL. In the error log you can read and analyze what errors have set the MIL and then delete the errors after the issue has been resolved. Noncritical faults are stored without activating the MIL.

- Repair Bleeding Wizard
Step-by-step instructions will guide you through bleeding the ABS unit, see also Repair Bleeding Wizard [▶ 31].
- Connectivity for data loggers and displays
You can connect a data logger (e.g. the C 70 from Bosch Motorsport) to the ABS-Wiring-Harness via CAN. The CAN Bus can give you wheel speeds and other readings from the system. All ABS M5 Porsche Cup Kit CAN messages can be displayed on any programmable, CAN-compatible display (e.g. the DDU 9 und DDU 10 from Bosch Motorsport), see also chapter “CAN Protocol V19 customer from 0700 onwards”.
- Switch the system on and off
Switch the system on or off via switch in the cockpit.
- Reset the system
Reset the system by switching to position OFF and back to ON.

3 Technical Data

Variations

Option	Kit 1	Kit 2	Club-Sport
F02U.V05.2	89-01	90-01	91-01 92-01 93-01 94-01 95-01 96-01
Customized wiring loom	+	+	-
ABS-Off position optional on position 1	+	+	-
Selection of ABS maps via Bosch 12-position switch or via specified CAN signal	+	+	+*
Motorsport connectors for wheel speed sensors	-	+	-
Flexible CAN terminals	+	+	+**
Downforce depending slip regulation	+***	+***	-
Lateral acceleration slip regulation	+	+	-
Corner inside wheel slip reduction regulation	+	+	-

+*: fixed Kit Content

+**: Adjustable via Coding Plug

+***: Enabled with customer specific calibration

Mechanical Data

Hydraulic unit	
Serial housing, dust- and damp-proof	
Vibration damped circuit board	
38 pin connector	
2 hydraulic valves per wheel	
2 brake circuits (front and rear)	
2 hydraulic high pressures pumps	
2 hydraulic accumulators	5 cm ³ /each
Standard fittings	2 x master cylinders M12 x 1 4 x brake cylinders M10 x 1
Size	122 x 110 x 122 mm
Operating temperature	-30 to 130°C
Max. shock	50 g less than 6 ms
Max. working speed	360 km/h = 100 m/s = 224 mph

Pressure Medium

DOT 4 brake fluid
DOT 5.1 brake fluid

Electrical Data

Supply voltage	10 to 16 V, max. 24 V for 5 min
Max. peak voltage	35 V for 200 ms
Power consumption Pump	230 W
Power consumption Relay	170 W
Power consumption Electronics	8 W

Inputs

4 active wheel speed DF11i, DF11S or DF11V
Brake pressure (front brake circuit / rear brake circuit)
Longitudinal acceleration, lateral acceleration, yaw rate (MM5.10 sensor)
11 adjustment settings (applicable for OEMs)
ABS function can be deactivated (Pos. 1 or Pos. 12)

Outputs

ABS warning light (MIL)
EBD warning light (MIL) if needed
TTL wheel speed signal FL / FR / RL / RR

Content of Kit and Weights

Hydraulic unit	1,910 g
2 pressure sensors	40 g/each
Yaw/acceleration sensor	60 g
12 position function switch	50 g
4 wheel speed sensors DF11 standard	50 g/each
ABS warning light (MIL)	50 g
Vehicle specific wiring harness with motorsport connectors	Depends on version
Clubsport wiring harness	1,540 g
Mounting and vibration-damping boards	80 g
Mounting board for hydraulic unit	212 g

Communication

ABS and Yaw rate sensor	CAN1
Diagnostics	MSA Box II

4 Disposal

Hardware, accessories and packaging should be sorted for recycling in an environment-friendly manner.

Do not dispose of this electronic device in your household waste.

5 Adaptations to your Vehicle

Physical vehicle data

For optimum brake performance, each ABS M5 Porsche Cup Kit unit has to be customized to suit the vehicle in which it is to be used. To do this, the system can be programmed by the user with certain data, such as the vehicle weight, vehicle dimensions, wheel circumference, and wheel weight. The system then uses this data as basis for calculation. Bosch will also program this data ahead prior to delivery; however, it is very important that you calibrate or verify the data prior to operating the vehicle.

You can find a form to fill in your vehicle data on www.bosch-motorsport.com. This form should be provided to you by your dealer with the order of the kit if the kit shall be programmed by Bosch.

Wiring harness

Each ABS system is delivered with a wiring harness that we have specifically created in accordance with customer requests.

With every Clubsport ABS you receive a standard wiring harness, which is not customized. Please see Wiring Harness ABS M5 Clubsport.



⚠ CAUTION

Use of ABS M4 wiring loom on ABS M5 system will damage the unit.

Though the connectors of both systems are identical, both systems require their own wiring loom.

System environment and related requirements

Is the ABS system being used as a closed stand-alone system? Or is it net-worked with a control unit?

If the system is networked with a standard control unit, we recommend that you use our speed/acceleration sensor with a CAN rate of 500 kBaud to avoid compatibility issues. Check the CAN speed in order to choose the same value for the ABS Kit.

If the system is networked with a motorsport control unit or used as self-sufficient stand-alone-system, we recommend that you use our speed/acceleration sensor with a CAN rate of 1 MBaud. This version features a greater measuring range.

If the system is networked with an ECU MS 6 or MS 7, we recommend that you use our speed/acceleration sensor with a CAN rate of 1 MBaud to avoid compatibility issues.



NOTICE

To avoid message ID conflicts care should be taken when networking with a production CAN bus.

Was or is the vehicle already fitted with an ABS system? Was or is it an old BOSCH ABS system?

ABS M5 Porsche Cup Kit requires signals from differential dual Hall sensors such as the Bosch DF11 or similar to function correctly. These sensor types are used in new vehicles for ABS and ESP® systems and can be carried over for the ABS M5 Porsche Cup Kit. The DF11 sensor element was first deployed by Bosch in 2006. Conventional inductive and Hall

sensors found in older series production ABS units will not function as transmitters for the ABS M5 Porsche Cup Kit. If your vehicle contains an older ABS system, you have to remove the wheel speed sensors and replace them by the sensors included in the package to be able to use the ABS M5 Porsche Cup Kit.

If you are not sure if your sensors are compatible with ABS M5 Porsche Cup Kit, Bosch Motorsport will gladly check that for you.

If you are fitting your vehicle with an ABS system for the first time, you may need an encoder wheel for each wheel and a sensor mount to record the wheel speeds. Please pay attention to the fitting position of the wheel speed sensors.

Do the wheel speed signals need to be communicated to other control units?

1. Option CAN
2. Option Wheel Speed TTL

ABS M5 Porsche Cup Kit delivers wheel speed Hall signals for FL, FR, RL and RR wheels as output. Connector is available on wiring harness under Wheel Speed TTL for FL, FR, RL and RR, see also System Overview [▶ 4]. The following graphic shows the spec as it is in the ECU. An example of the front left wheel is shown.

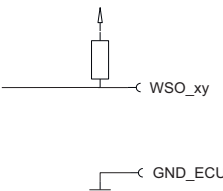
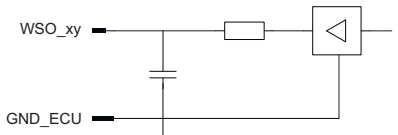
Signal Name: WSO_FL				Pin Number: 23		
Schematic (vehicle side)				Interface circuit (ECU side)		
						
Item	Min	Typ	Max	Unit	Remarks	
Reference		GND_ECU				
DC output current, I _{out}			50m	A		
H voltage level, U _{out_high}				V	Open collector	
L voltage level, U _{out_low}			1.5	V	@ I ≤ 50mA	

3. Option Wheel Speed Interface

We developed a wheel speed signal splitter that duplicates the signal from the wheel speed sensor. This is useful for providing a DF11 signal to other systems in the car, which are also adapted to this signal type, such as specially adapted displays and data loggers. This is not intended to transmit signals to OEM controllers.

6 Included in the Kit

6.1 ABS M5 Kit Porsche 991 Cup

ABS M5 Kit Porsche 991 Cup includes the following parts, which are also available as individual spare parts (Hydraulic unit only in exchange):

Hydraulic unit with attached ECU	
Holder for Hydraulic unit	Porsche specific
2 pressure sensors	
MM5.10 acceleration sensor	
Vibrations damping board for acceleration sensor	
12 position function switch	
ABS warning light (MIL)	LED type
Specific wiring harness	
Brake pipe fittings	
Fuses	
Fuse mounting bracket	

6.2 ABS M5 Kit Porsche 997 Cup

ABS M5 Kit Porsche 997 Cup includes the following parts, which are also available as individual spare parts (Hydraulic unit only in exchange):

Hydraulic unit with attached ECU	
Holder for Hydraulic unit	
4 wheel speed sensors	Porsche specific DF11S
2 pressure sensors	
MM5.10 acceleration sensor	
Vibrations damping board for acceleration sensor	
12 position function switch	
ABS warning light (MIL)	
Specific wiring harness	
Fuse mounting bracket	

7 Assembling the Parts

7.1 Hydraulic Power Unit with attached Control Unit

- 1 MC2: Brake master cylinder rear
- 2 RR: Brake cylinder rear right
- 3 RL: Brake cylinder rear left
- 4 FR: Brake cylinder front right
- 5 FL: Brake cylinder front left
- 6 MC1: Brake master cylinder front

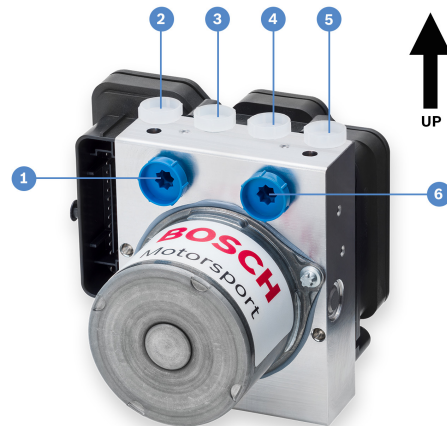

The hydraulic power unit with attached control unit has six hydraulic connections: two for the master cylinders (one for the front and one for the rear axle) and four for the brake cylinders.



CAUTION

The hydraulic power unit is prefilled with brake fluid. During assembly, make sure as little brake fluid as possible is lost.

When installing the hydraulic power unit, make sure the wheel brake line connections are facing upwards to ensure air can be bled out. Secure the hydraulic power unit to the assembly plate supplied with the ABS M5 Porsche Cup Kit using the M10x1 screw thread on the underside of the casing. To reduce vibration, rubber pads should be fitted between the assembly plate and the vehicle chassis. To allow easy connection of the main ABS ECU connector, maintain a 10 mm distance between the vehicle chassis and the bottom of the assembly plate.



NOTICE

Correct position for installation: wheel brake line connections should face upwards.

Install with rubber pads/blocks to reduce vibration.

Leave 10 mm or larger gap in between the vehicle chassis and bottom of assembly plate.

For more on assembly see Offer Drawing Hydraulic Unit [▶ 41].



NOTICE

Conform to FIA rules for GT3

With only 8 active hydraulic valves, the ABS M5 Porsche Cup Kit conforms to FIA rules regarding brake modulation hardware.

**NOTICE**

We recommend an exchange of the hydraulic power unit after one year.

In racing vehicles, hydraulic units are subjected to significantly higher loads than in production vehicles. We therefore recommend replacing them even when they are fully functional, to keep the residual risk of failure as low as possible.

7.2 Brake Pressure Sensor



Install the brake pressure sensors into the front and rear axle brake circuits between the master cylinders and the hydraulic power unit. The sensors are metric thread, M10x1. Before assembly, fill the sensors with brake fluid, e.g. with a small medical syringe. So the brake system can be fully bled, the measuring holes of the brake pressure sensors should point upwards.

**NOTICE**

The use of other than the supplied sensors will destroy the unit permanently. ABS M4 sensors are not compatible with ABS M5.

Install into the front and rear axle brake circuit between the master cylinder and the hydraulic power unit as far away from the ABS unit as possible to avoid damages due to vibration.

Fill sensor with brake fluid before installing.

For more on assembly see Offer Drawing Brake Pressure Sensor [▶ 43].

7.3 Wheel Speed Sensors



Bosch Motorsport ABS M5 Porsche Cup Kit needs specific wheel speed signals, which are supplied only from active speed sensors like e.g. from Bosch DF11-family. These double hall sensors operate on the differential principle. The ABS M5 Porsche Cup Kit needs all four speed sensors to function; otherwise the system assumes there is an error and shuts down. Therefore, you should exclusively use the speed sensors as supplied in the ABS M5 Porsche Cup Kit-Kit (see section Offer Drawing Wheel Speed Sensor [▶ 42]). Existing wheel speed sensors can be tested and approved by us.

Pay attention to the polarity when you are connecting wheel speed sensors.

Install the sensor in the right direction, i.e. the encoder wheel and sensor must lie in the defined installation position (fixation screw in rotation position of the encoder wheel). The sensor will not work if you install it in a position other than the recommended installation

position. Make sure the sensor is mounted and secured as tight as possible to prevent sensor errors or failures from vibration. You can find the sensor's dimensions and how to install the sensor on Offer Drawing Wheel Speed Sensor [▶ 42].



NOTICE

Use only differential sensors, like Bosch DF11 or similar. Supported sensors: DF11i, DF11S and DF11V.

Securely mount sensors and pay attention to correct mounting position (sensors direction sensitive). Choose sensor mounts that are as still as possible. Sensor dimensions and mounting requirements can be found in the Offer Drawing Wheel Speed Sensor [▶ 42].

7.4 Encoder Wheel

Encoder wheels usually have 48 teeth. The tooth/gap ratio should be 50 % and the teeth should be 3 mm in height. The encoder wheel must be made of a ferromagnetic material. If required, Bosch Motorsport can provide technical documentation on positioning the encoder wheel. See the back cover of this booklet for our contact information.

7.5 Distance between the Sensor and the Encoder Wheel

You can adjust the distance between the sensor and the encoder wheel to fit the encoder wheel's dimensions and other installation conditions, but gap is normally between 0.8 ± 0.1 mm.



NOTICE

**Use a ferromagnetic incremental wheel.
Leave a 0.8 ± 0.1 mm gap between sensor and encoder wheel.**

For more on assembly see Offer Drawing Wheel Speed Sensor [▶ 42].

7.6 Yaw/Acceleration Sensor

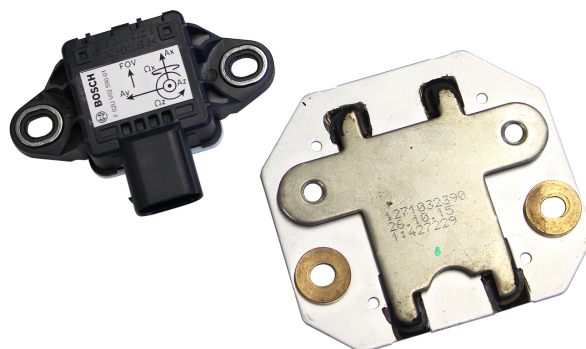

ABS M5 Porsche Cup Kit uses a yaw rate sensor from the MM5.10 generation with CAN speeds of 500 kBaud or 1 MBaud. The yaw/acceleration sensor is specific to the system and should be mounted as close as possible to the center of gravity of the vehicle. The sensor should be assembled with the supplied damping plate. Position the sensor so that the connector is pointing towards the rear of the vehicle.



NOTICE

For system combination with ECU MS 6 or MS 7, the 1 MBaud sensor is required.

The ABS system will not work if you choose any alternative yaw rate sensor.



NOTICE

Only use the provided kit sensor.

Use the damping plate.

Make sure the sensor is facing the correct direction see image above.

7.7 Map Switch



Max. tightening torque:
1-2 Nm!

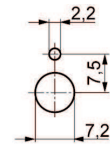

Front-panel cut out with locating lug

While driving, the driver can use the map switch to select different control settings and find the optimum setting for his/her driving style. For this reason, make sure the switch is mounted within reach of the driver. Many have found it helpful to fit a diagram showing the current switch position, see also Features [6], diagram in chapter. The switch position is also broadcast on the CAN Bus so it can be displayed with a dash (e.g. the DDU 9 and DDU 10 from Bosch Motorsport).



NOTICE

Only use the supplied Map Switch.

Do not exceed the max. tightening torque of 1 to 2 Nm. Over-torquing can damage the switch or make it difficult to turn.

Remove the front cover of the switch to access the retaining hardware.

7.8 Warning Light (MIL)



LED



Front-panel cut

The included wiring harness is structured in such a way that the power supply to the warning light (MIL) is branched off before the main switch for ABS M5 Porsche Cup Kit (terminal 30). This is the only way to ensure that the warning light (MIL) is lit when ABS M5 Porsche Cup Kit is not working.

Cable length connector to electronic board: 600 mm



NOTICE

The MIL will stay illuminated in the following cases:

Map switch is in the OFF position

The user is connected to the car via the RaceABS tool and MSA Box

There is an active fault disabling ABS M5 Porsche Cup Kit



NOTICE

The MIL will toggle for two seconds

in case of a wheel sensor signal event which will trigger the wheel quality flag. If the event is too short to trigger an ABS error message, the lamp will toggle for two seconds after the last event. This signals a possible imminent sensor failure. Passing curbs can affect this event.

In case of toggling of the lamp, the ABS control will be frozen for the wheel which is affected over the event duration.

7.9 Brake Lines

All hydraulic connections between ABS M5 Porsche Cup Kit Use rigid steel brake lines with a diameter of 3.3 mm for as much of the plumbing as possible. Flexible line should be kept to an absolute minimum for optimal brake control and pedal feel.

The ABS M5 Porsche Cup Kit units use a DIN (bubble) flare convention common to European OEM applications. The best and simplest way to adapt the system hydraulically is with an M12x1 DIN tube nut on the ports. Tube nut size should be fitting to the hard line size used. Adapters should be avoided if possible.

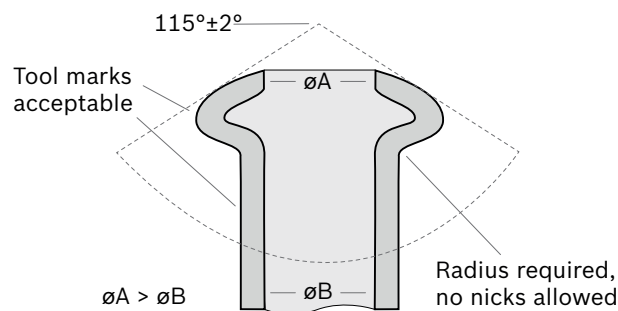

The EBS unit is secured in the vehicle on the provided mounting board. During operation, the EBS unit will vibrate. These vibrations are then transferred to the brake lines. To prevent vibration-induced damage to the brake lines, they must not be secured at up to 20 cm from the EBS unit so that they can vibrate freely.



NOTICE

We recommend using rigid metal brake lines; use flexible lines only at points where they are necessary.

Do not secure brake lines 0 to 20 cm from the EBS unit. The unit vibrates and would cause risk of damage to the lines.

Use brake lines with a minimum inside diameter of 3.2 mm.

7.10 Brake Calipers

Use brake calipers that are as stiff as possible. Any flex in the brake caliper causes extra fluid volume that must be regulated by the ABS M5 Porsche Cup Kit, which reduces performance.

During ABS M5 Porsche Cup Kit operation there will be a significantly higher load on the brake piston seals. For this reason, brake piston seals will require more frequent monitoring.



NOTICE

Monitor brake piston seals more often.

Use brake calipers that are as stiff as possible.

The higher the brake pressure is, the larger is the elasticity of the brake. A locking pressure of max. 80 bar is optimal.

7.11 Master Cylinders

The master cylinders in a race car equipped with ABS are heavily exposed to piston vibrations due to ABS return fluid pump.

Test and inspect the master cylinders frequently, both to ensure safety as well as to avoid damage to the ABS unit.



CAUTION

Test and inspect the master cylinder frequently.

7.12 Pressure Medium

Brake components and systems are designed for exclusive use with the following glycol/glycol ether-based brake fluids, including their mixtures:

- DOT 4 (including SAE/ISO/JIS sub-classes)

- DOT 5.1

according to

- FMVSS 116, Issue 16.10.2015
- SAE J 1703, Issue 28.08.2014
- SAE J 1704, Issue 28.08.2014
- DIN ISO 4925, Issue 05.02.2014
- JIS K2233, Issue 20.06.2006

In general, brake components and systems are designed to operate with these generic brake fluid categories. However, brake fluid characteristics impact performance and reliability.

For use in motor racing, some manufacturers offer fluids with a boiling point of over 300°C. These are highly hygroscopic and therefore should be replaced more often than usual. Please follow the brake fluid manufacturer's recommendations regarding testing and changing.

8 Laptop Communication

The MSA-Box II from Bosch Motorsport is the communication interface between ABS M5 Porsche Cup Kit and the programming and diagnostic software on your laptop. The MSA-Box II has two connectors: a USB connector for connection to the laptop and a motor sports connector for connection to the mating connector in the vehicle wiring harness.



Installing the MSA-Box II driver:

Before using the MSA-Box II for the first time, you need to install a specific driver on your laptop. Find the driver for free download on our website www.bosch-motorsport.com.



NOTICE

Please make sure that the MSA-Box II is not connected to the laptop while you are installing the driver.

Connect the MSA-Box II to the laptop after installing the driver. This will trigger the initial communication between the laptop and the MSA-Box II. Follow any prompts that may follow to install the MSA-Box II. Once you complete any prompts and computer recognizes the MSA-Box II, the MSA-Box II is ready for use.

Steps:

1. Unplug the MSA-Box II from the laptop.
2. Install the driver.
3. Plug the MSA-Box II into the laptop.

You can connect ABS M5 Porsche Cup Kit to a laptop with the MSA-Box II via the "diagnosis interface" connector. The diagnosis interface connector should be placed so it is easily accessible. You can use programming and diagnosis software, see section Programming and Diagnosis Software [► 23], to program settings specific to the vehicle and open/delete error messages.

9 Programming and Diagnosis Software

9.1 Installing the Programming and Diagnosis Software

After installing the MSA-Box II you need to install the programming and diagnostic software RaceABS. You can find the software for free download on our website: www.bosch-motorsport.com

Switch on the ignition

Plug the MSA-Box's USB connector into your laptop and its motorsport connector into the ABS M5 Porsche Cup Kit wire harness diagnostic interface to enable communication.

The installation creates a shortcut on your desktop to the RaceABS software. Click it to start the application. A green status indicator shows when the connection is successful. A window pops up where you can select your brake version to load.

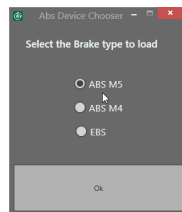

If you try to launch the software without the MSA-Box II to laptop connection, the status indicator in Explorer lights red / yellow and an error message appears in the status bar:



The following message pops up when either the ABS M5 Porsche Cup Kit-ECU gets no power supply (e.g. ignition OFF) or the MSA-Box II is not connected to the wiring harness. Please make sure that the connection between the diagnosis software and MSA-Box II is assured:

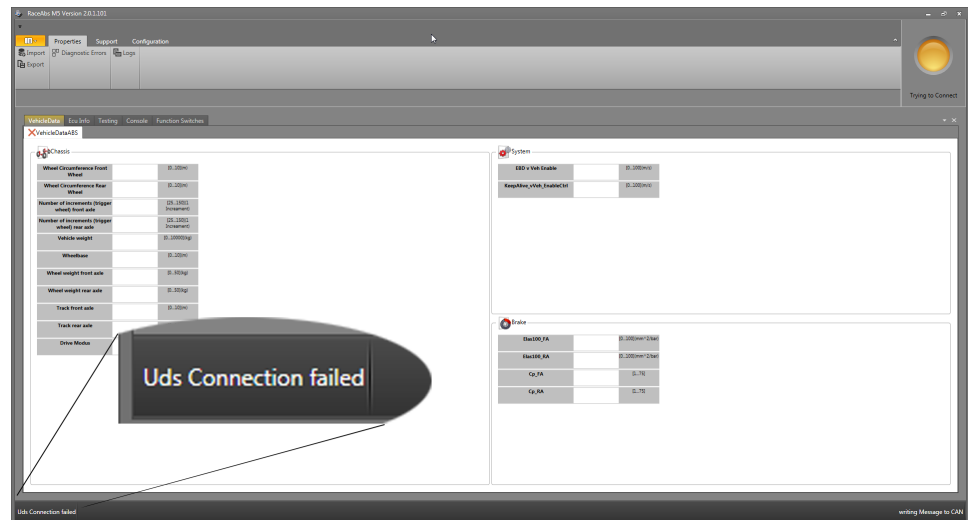

Colors of the status indicator

The status indicator can shine in the following colors:

Red	No connection
Yellow	Connection in progress or MSA-Box II cannot create a connection with the ABS M5 Porsche Cup Kit (e.g. ABS M5 Porsche Cup Kit switched off)
Green	Connection successful, Online mode
White	Offline mode
Red / Yel- low flashing	MSA-Box II is not connected to the laptop

Change between Online and Offline Mode

If a connection does not exist, it is easier to operate with the diagnosis software in offline mode. Please click with the right mouse button on the green status indicator to choose between online and offline mode:

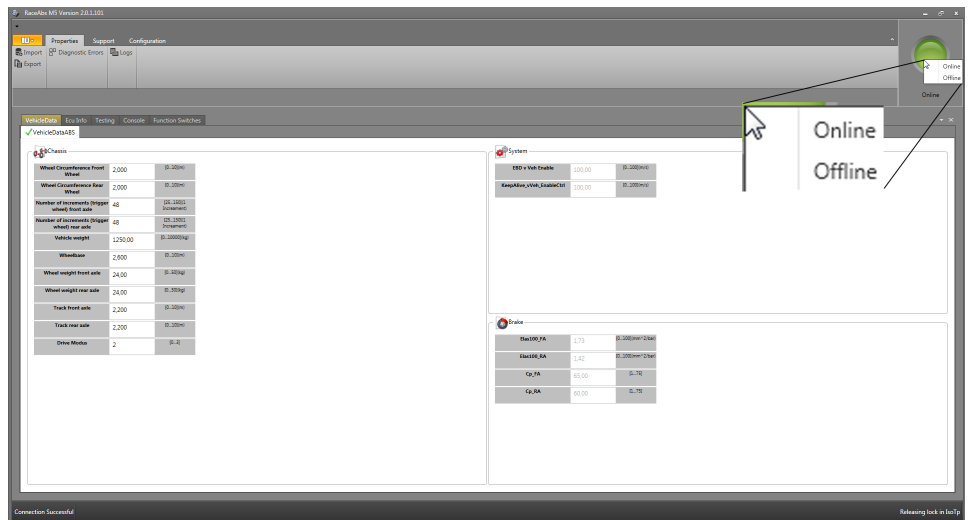

A green status indicator signals the online mode; a white status indicator signals the offline mode.



NOTICE

You can only change the status when the ABS M5 Porsche Cup Kit tree is closed.

Custom Theme Selection

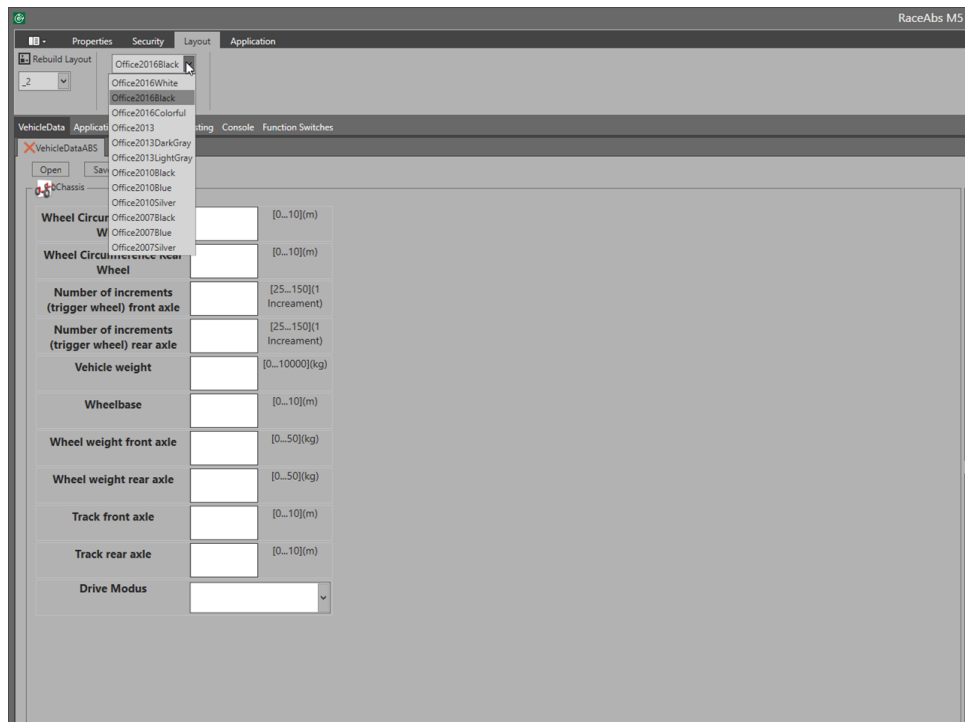

Selection of Custom Themes / Skin is now possible in RaceABS. This helps the customer to configure the Tool as per his requirements.

9.2 Features of the Programming and Diagnosis Software

9.2.1 Diagnostic Code

The ABS M5 Porsche Cup Kit-ECU sends the stored errors as coded data to RaceABS. These codes are then translated by a translation file and displayed on the page "Ecu Info" in RaceABS as plain text.

After installation of RaceABS, a default file will be used for the translation. If you don't see plain text or if there is an orange colored warning, you do not have the matching translation file to your software. With a not matching file, some codes cannot be translated or might be translated in the wrong way. Therefore it is important to use the correct translation file.

To get the correct translation file, please conduct the following steps:

- Check on the top of the "ECU Info" page which software number and software version is used in your ABS M5 Porsche Cup Kit.
- Go to the Bosch Motorsport homepage and download the matching diagnostic translation file to your software. You will find in the naming of the diagnostic translation file the software number as BB number and the version as a V number, zeros at the end might be skipped in the naming. The numbers of the file need to match the numbers of the software. The file is an .XML file.
 - For example if your ABS M5 Porsche Cup Kit runs on the software 96242 and the version 03.00.00.00.00.00. You will need the file `TKWINX_FAILUREMEMORYDESCRIPTION_BB96242_V0300.XML`
- Store the file on your computer.
- Click in RaceABS on "Properties" - "Diagnostic Errors" and select the matching diagnostic translation file.

You will find the most common translation files on our homepage. If your needed file is missing, please contact your dealer or the OEM customer service.

9.2.2 Vehicle Data

You can find a form to fill in your vehicle data on www.bosch-motorsport.com. This form should be provided to you by your dealer with the order of the kit, if the kit shall be programmed by Bosch.

If you need to replace the ECU or modify the programmed vehicle data, you can update the data in the software by yourself.

Within the window "Vehicle Data ABS M5 Porsche Cup Kit", a short declaration or the measuring unit for each value can be shown. By holding the cursor over a data range, a small window with the declaration occurs.

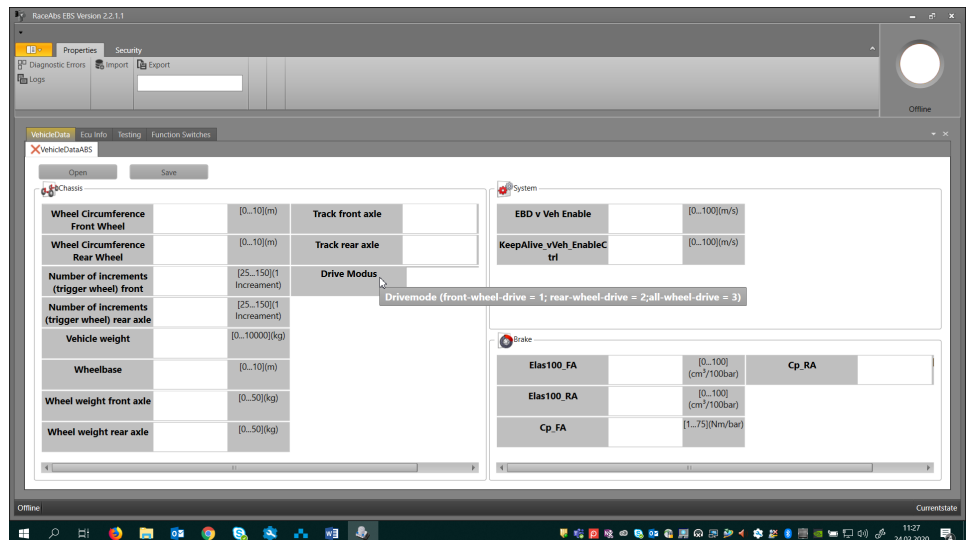

You can save and open the vehicle data of the window "Vehicle Data ABS M5 Porsche Cup Kit" separately. Therefore, click the SAVE button.

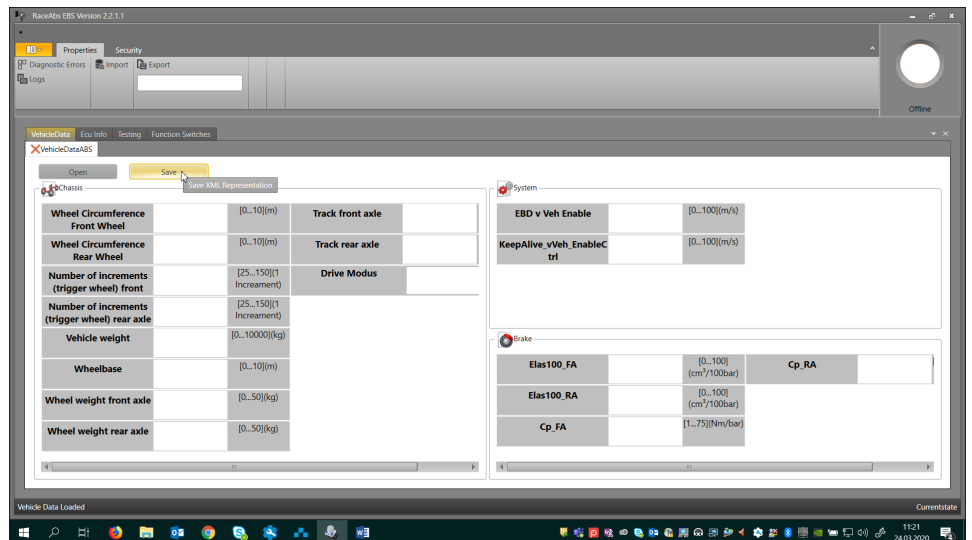

NOTICE

Only the active window will be saved.

Default value for the map switch

For the 12-position map switch, you can specify a default value. If the function switch fails for any reason, the switch automatically takes the position of the default value. To assign a position for the default value, select a number between one and twelve under "MultiSwitch" in the field "Default Position":

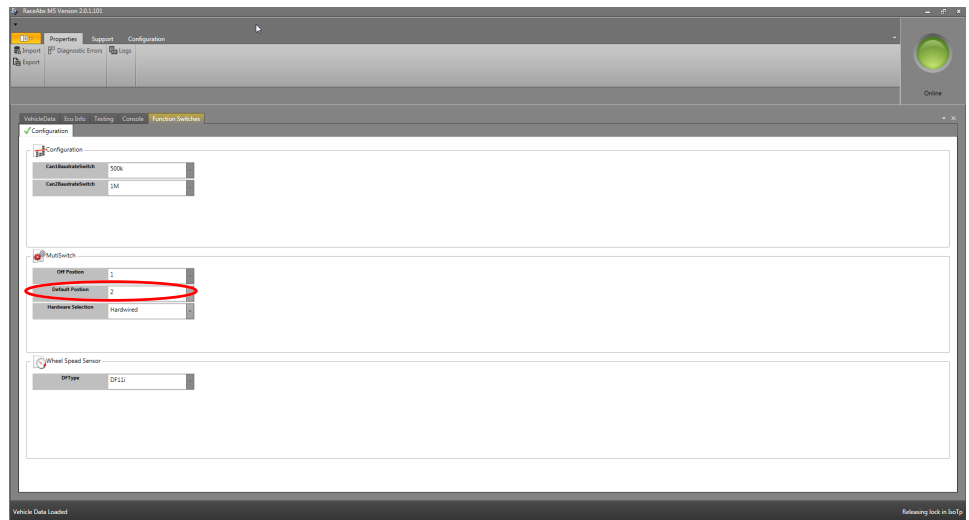

NOTICE

You may want to be strategic about how you make this setting, for example, making it the best compromise position for all conditions.

9.2.3 Testing

After assembling the system components, you need to carry out a function test before the first test drive. This test will ensure all components (electrical and hydraulic) were assembled correctly and are functioning properly. The vehicle should be placed on four jack stands or on a hoist so that all four wheels can be moved freely. If there is no other option, you can lift and test each wheel separately. You will need an assistant to help you check the hydraulic allocation of the wheels.

Step 1: Testing the communication with the ABS M5 Porsche Cup Kit ECU

See section Laptop Communication [▶ 22].

Step 2: Testing the wheel speed allocations

With the vehicle jacked up, spin individually all four wheels clockwise and check for the proper front/back, left/right allocation. When you spin each wheel, the corresponding position should show a value in the RaceABS software under the "Testing" tab:

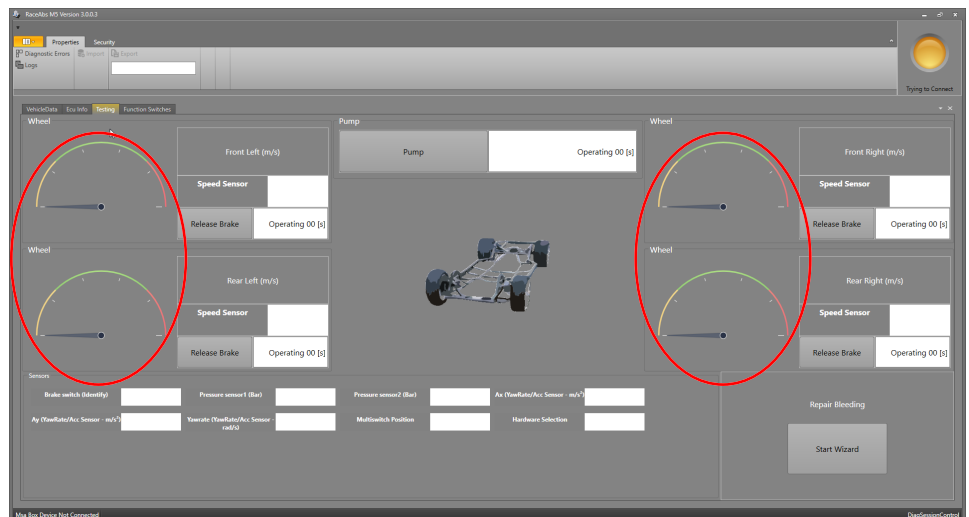

You just do this to see if a signal is received by the ABS M5 Porsche Cup Kit unit. This is not a signal quality check.

Step 3: Testing the hydraulic allocations

Have an assistant apply the brake pedal and maintain the brake pressure so all four wheels of the jacked up vehicle are locked. Therefore, a brake pressure of 15 to 20 bar is sufficient. Unlock each wheel successively by clicking on "Release Brake". The selected wheel should run free now.

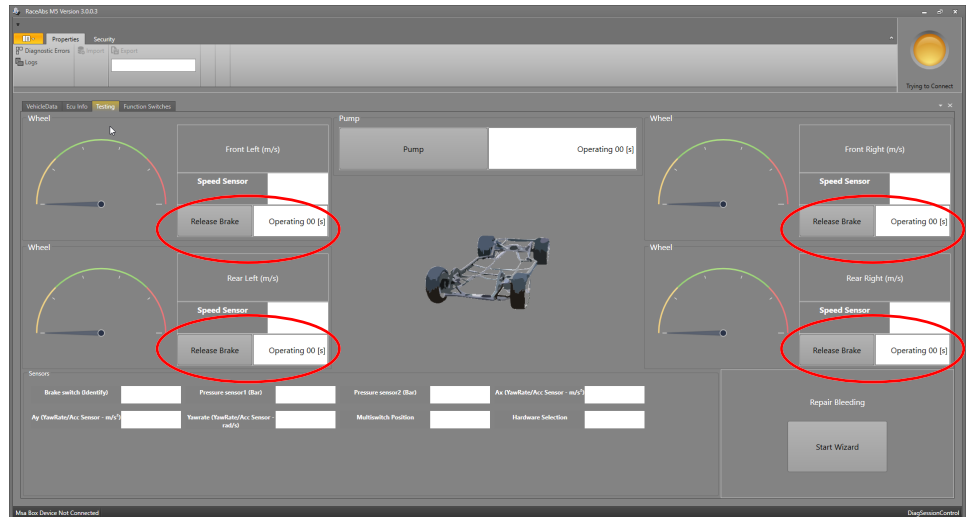

NOTICE

Certain vehicles require a high torque input at the wheel to overcome the effect of residual brake pressure and resulting torque.

Step 4: Testing the electrical pump motor

If you click the "Pump" button, the pump motor should run for 10 seconds or till you click the button again.

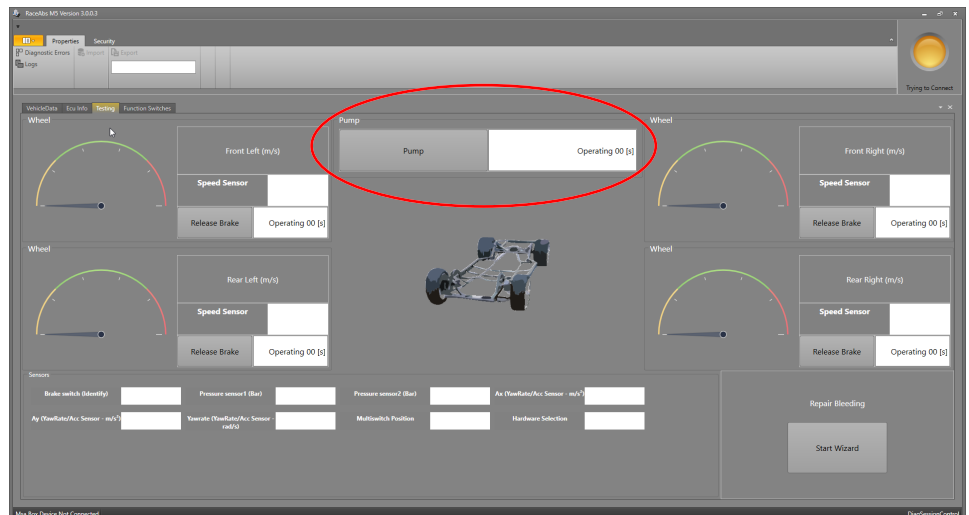

Step 5: Testing the function of the brake pressure sensor and brake light switch

Start the RaceABS with connection to the MSA-Box II and press the brake pedal for a few seconds with slowly rising pressure. The digital display "Brake switch" bit should toggle from 0 to 1, see screenshot below.

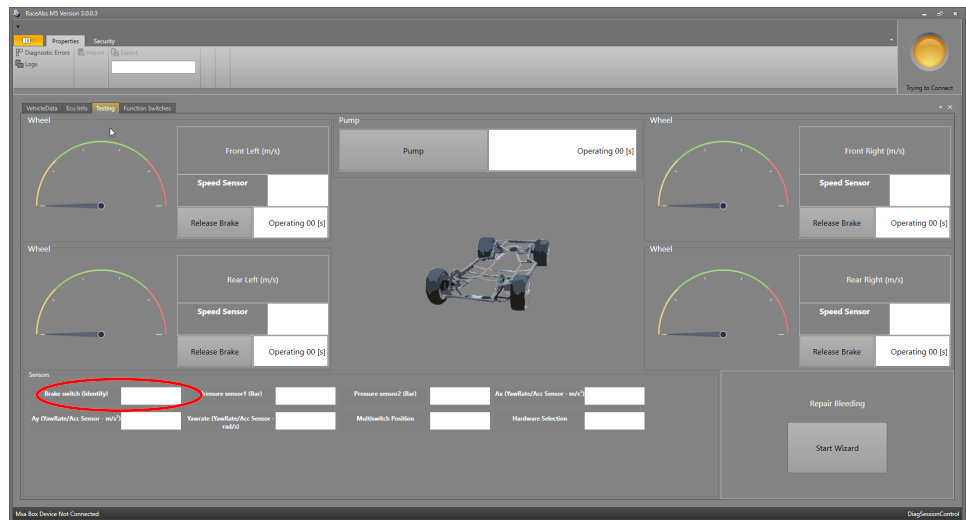

If the bit does not toggle, check the pressure sensors. The brake light switch bls is a function of the pressure sensors.

The digital display „Pressure sensor“ should show a logical value, e.g. 3.87, in the screenshot below.

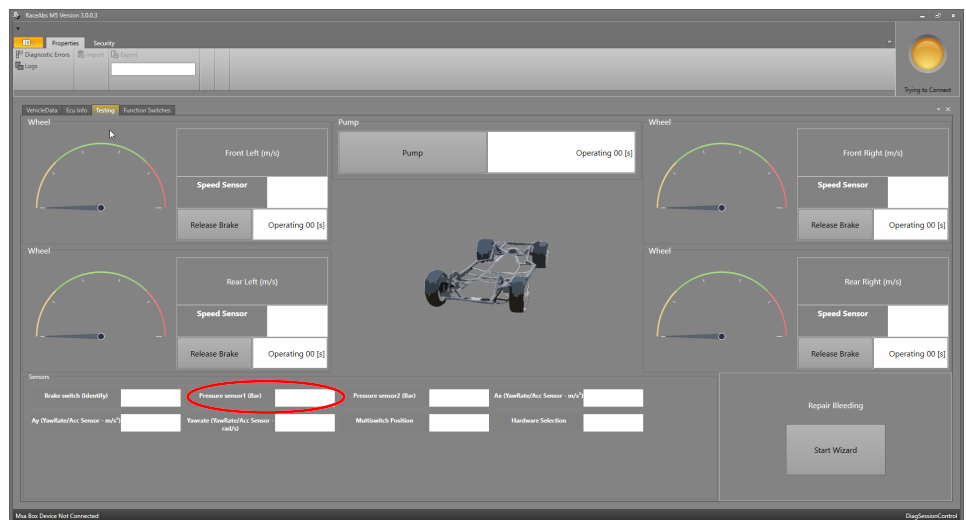

If the software displays no value or an illogical value, open the “ECU Info” tab and check the error memory. Do you find errors relating to the brake pressure sensor? See section ECU Info (Diagnostics) ▶ 33] for more information regarding ECU diagnostic errors.

Step 6: Testing the function of the map switch

Turn the 12-position map switch through full rotation. With every step, the number of measuring points should increase by 1.

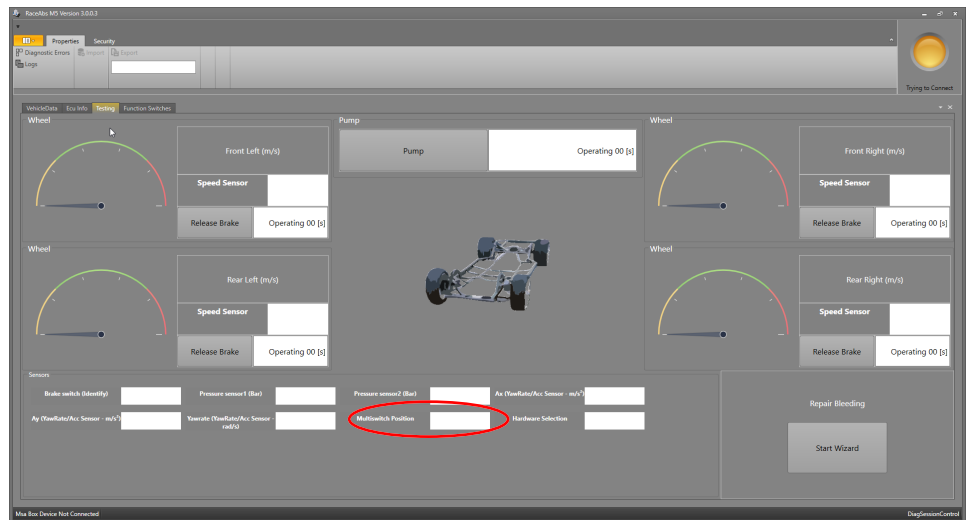

NOTICE

MIL shines permanently in diagnosis mode.

9.2.4 Repair Bleeding Wizard

Under the “Testing” tab of the RaceABS software you will also find an area at the bottom right, labeled “Repair Bleeding” with the button “Start Wizard”. With this button, you will be guided through the bleed of the ABS M5 Porsche Cup Kit unit. This might be required if air might got trapped in the accumulator of the ABS M5 Porsche Cup Kit unit. It is recommended to perform the ABS M5 Porsche Cup Kit unit bleed after installation or if air got trapped in the brake lines and might got caught in the ABS M5 Porsche Cup Kit unit.

Click on the button “Start Wizard”, a new window will open and lead you step by step through the instruction for bleeding the ABS M5 Porsche Cup Kit unit. You will need three people to conduct the instruction.

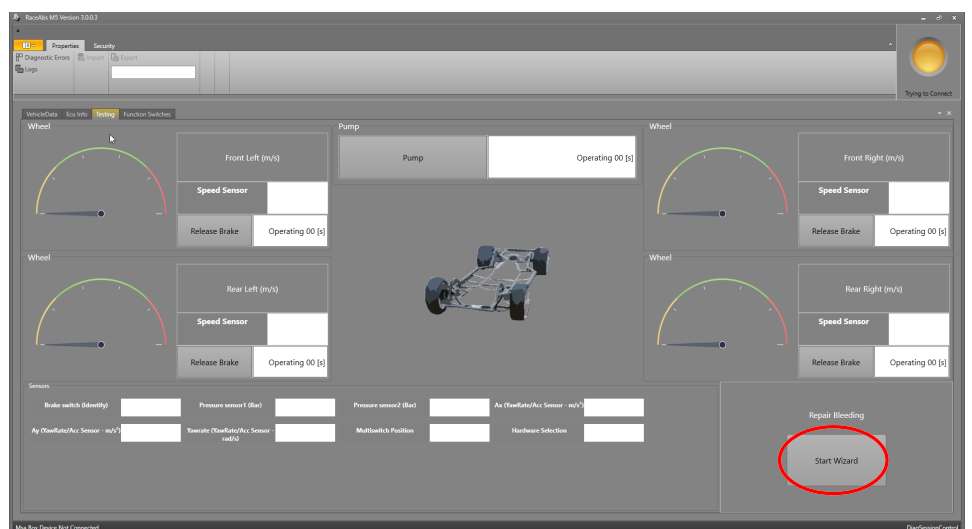



NOTICE

The Bleeding Wizard is only for bleeding the ABS M5 Porsche Cup Kit hydraulic power unit. The Bleeding Wizard is NOT to be used or substituted for bleeding the other parts of the brake system, like lines and brake cylinders. Make sure to bleed these other hydraulic parts of the brake system before and after bleeding the hydraulic unit with the Repair Bleeding Wizard.

During the ABS M5 Porsche Cup Kit bleeding process the brake pedal should be actuated continuously except when opening or closing brake bleeder valves.

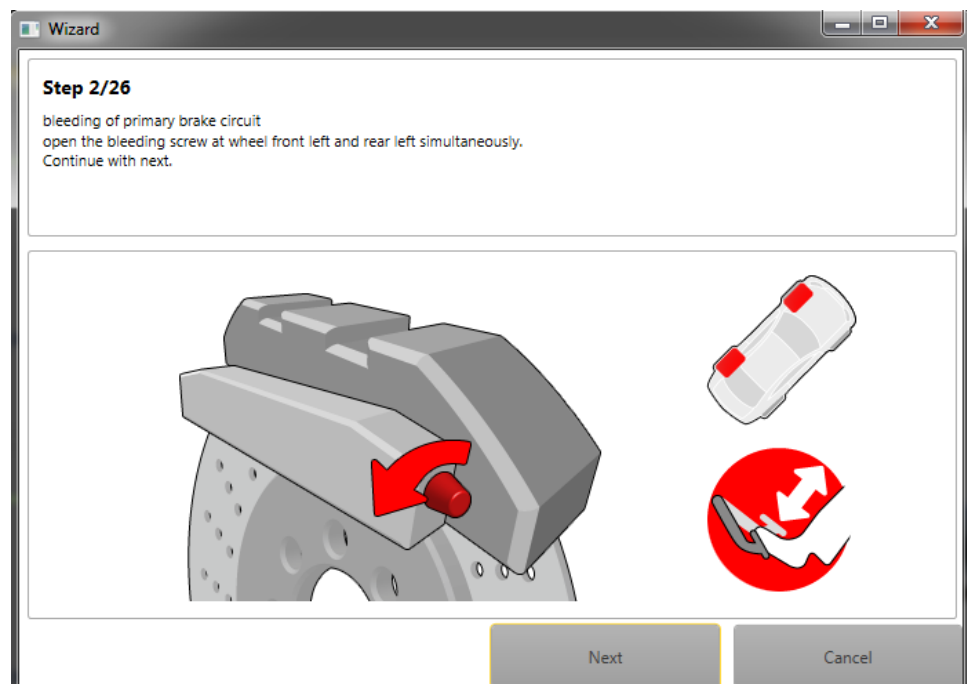
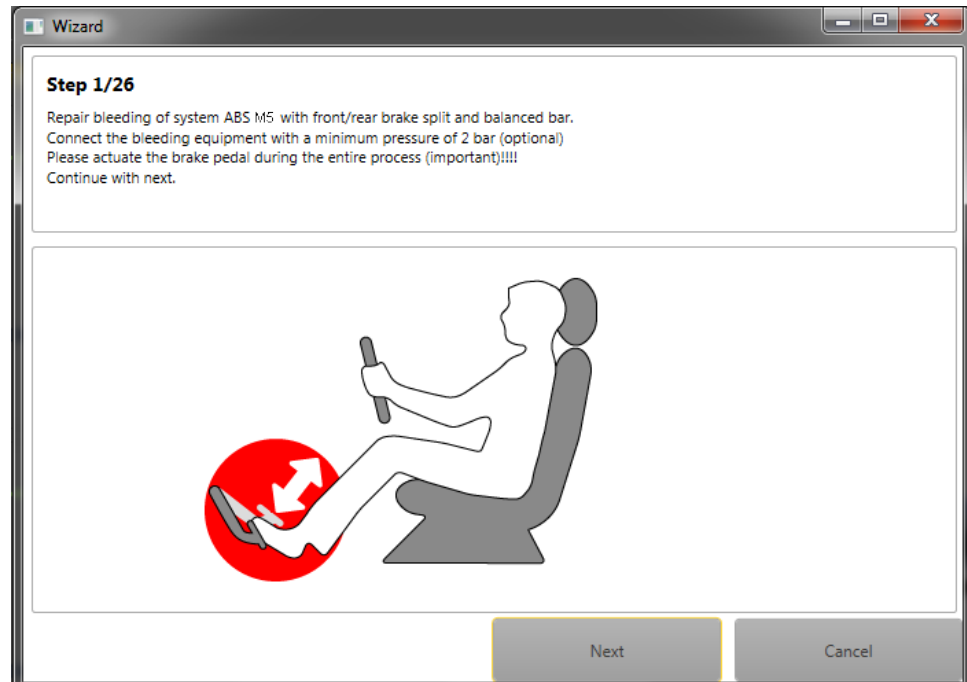



NOTICE

For vehicles with brake balance bar, please open one front and one rear bleeder valve for proper function of the balance bar during the bleeding routine procedure.

9.2.5 ECU Info (Diagnostics)

Indication lamp

When you turn on the ignition or the ABS M5 Porsche Cup Kit, the warning light (MIL) comes on briefly and then turns off again. This indicates the light's self-testing process. If the warning light (MIL) does NOT light up when you turn on the ignition or the ABS M5 Porsche Cup Kit, you must establish the reason for this before taking any further action or before driving the vehicle.



NOTICE

The MIL will stay illuminated as long as the diagnostic tool is switched on.

Error log

If the warning light (MIL) is illuminated PERMANENTLY when you turn on the ignition or the ABS M5 Porsche Cup Kit, or while driving, there is a system error. Extract the system's internal error log to analyze the error. You can access the log by clicking on the "ECU Info" tab in the RaceABS software.

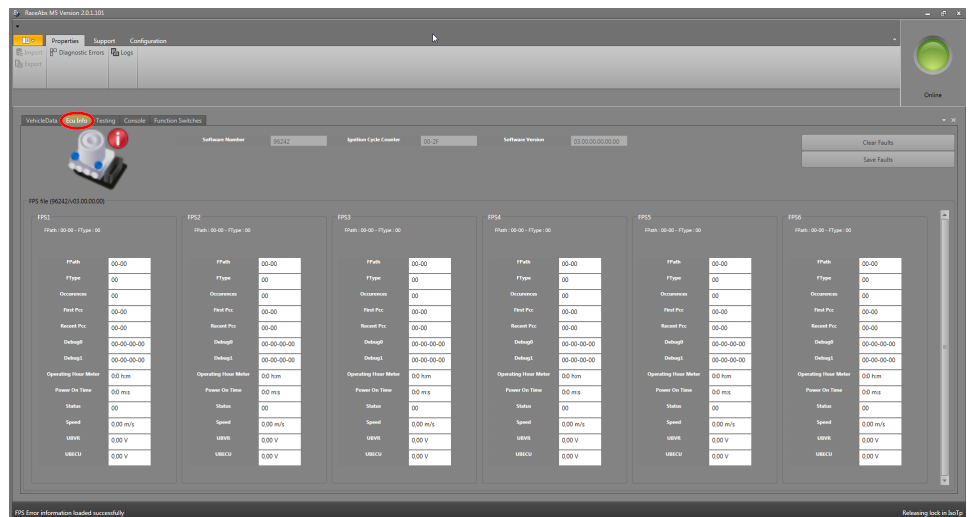

NOTICE

Multi switch = Map switch



NOTICE

System reset after drive cycle faults.

Drive cycle faults, e.g. because of wheel speed sensor bug, need an **ABS M5 Porsche Cup Kit-ECU reset (Power off - Power on)**. After the reset, the car has to accelerate to more than 12 km/h for system check.

Save error log entries

If any error log entries occur which are not listed above, please contact your dealer or the OEM customer service. Communication would be easier if you also send a copy of your error log entries.

Click on the right button named "Save Faults" to get a copy of the error log entry.

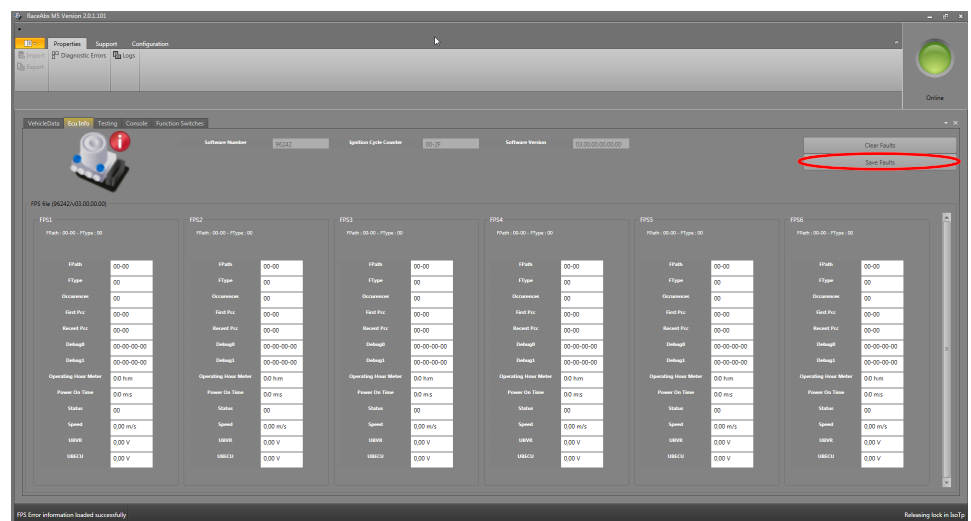

Delete error log entries

After carrying out the problem-solving actions, delete the entry from the error log by clicking on the "Clear Faults" button, as seen below:

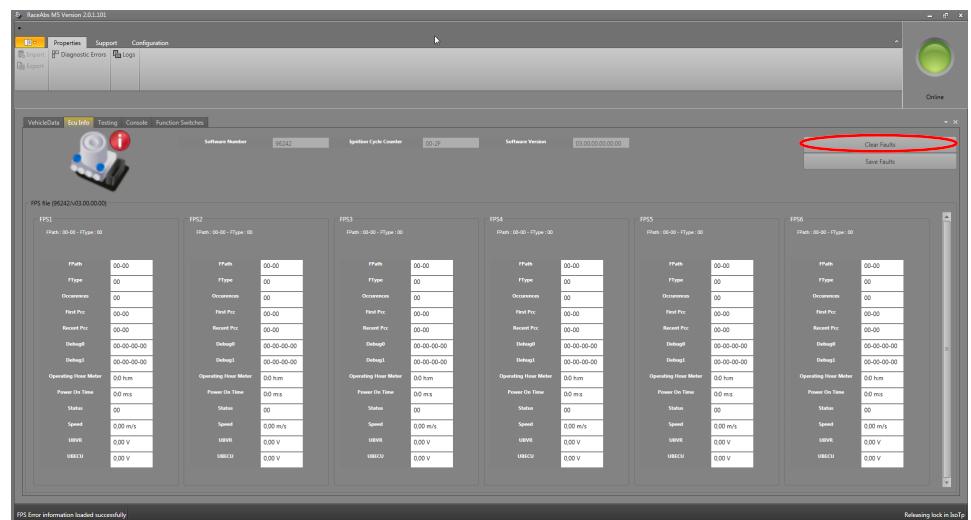

Then turn ABS M5 Porsche Cup Kit off and on again. After you deactivated the software, the indication lamp will no longer glow.

**NOTICE**

If the faults are not all clearly described or if there is no error description, please check if you used the correct FPS-File or contact Bosch Motorsport for update.

Ignition Cycle Counter

The ignition cycle counter shows how often you switched on the ignition. If you compare the values of the ignition cycle counter and ICC at Failure Occurrence you can trace back at what time the faults occurred. If both fields show the same values, it is an actual fault.

10 Startup Checklist

This short checklist is intended to supplement the ABS M5 Porsche Cup Kit's manual, not replace it. Prior to using this checklist, the user/installer should read the ABS M5 Porsche Cup Kit manual, especially section Laptop Communication [▶ 22] to Assembling the Parts [▶ 15].

Basics

- Hydraulic unit with attached control unit mounted correctly (mounting plate used, brake lines facing upwards), see section Hydraulic Power Unit with attached Control Unit [▶ 15].
- Brake pressure sensor and Yaw/Acceleration sensor installed in proper locations? See section Brake Pressure Sensor [▶ 16] and Yaw/Acceleration Sensor [▶ 17].
- Everything plugged in to harness, power ring terminals connected to battery, ground ring terminals connected to solid and clean chassis ground, circuit breakers installed properly, map switch turns off system. See section Brake Pressure Sensor [▶ 16] and Yaw/Acceleration Sensor [▶ 17].

Software Tool and Error Checking

- Connect to the ABS M5 Porsche Cup Kit control unit with MSA-Box II using RaceABS Software and ensure that all vehicle data has been entered correctly. The vehicle data can be saved and or loaded by right clicking in the screen.



NOTICE

Once the diagnosis software RaceABS is connected to the harness, the warning light (MIL) will light up and remain lit until it is disconnected. See section Testing [▶ 28], Step 2. If the MSA-Box II is not connected to the laptop, the indication lamp illuminates yellow.

- With the system on, switch to the "ECU Info" page and clear errors with clicking on Clear FPS. Wait a moment (system will self-refresh error stack). Reset the system by switching off/on. Check if any errors reappear in the error stack. If errors reappear, diagnose errors before proceeding. If anything was unplugged during the diagnostic process, errors will be present and need to be removed from the error stack. Next, cycle ABS M5 Porsche Cup Kit on/off switch and verify no errors are present after cycling power, see section ECU Info (Diagnostics) [▶ 33].

Error Notes

- In case of use of a wheel speed signal splitter: If the wheel speed signal splitter is disconnected, all four wheel speed sensors will have error entries.

Function Check

- While connected with the RaceABS software switch to the "Testing" page. Check all sensors for plausibility and proper function. Delete the balance bars. Press brake pedal: brake switch bit should toggle between 0 and 1, the display "Pressure sensor" should show a logical value. Check sensor and balance bar, if the brake switch doesn't toggle. Rotate map switch, the value "Multiswitch" should turn up clockwise. Manually

move yaw/accelerometer sensor to the right and left as well as to the front and rear. The "Ax" and "Ay"-values should increase positive or negative analogue to the Tilt. See section Testing [▶ 28].

- Put the car on jack stands so all wheels can be freely rotated. While connected with the RaceABS software and viewing the "Testing" page, rotate each wheel and verify the correct wheel speed responds in the "Testing" page, see section Testing [▶ 28].
- Click "Pump On" button on the "Testing"-page. The pump now runs for 10 seconds or until you press the button again. After the pump shuts off, an assistant hold the brake pedal down (Please check: all wheels have to be locked!) Next, while the assistant still holds brake pedal down, click the "Release Brake" button for a given wheel (one at a time). Verify that brake releases at that wheel by rotating the wheel before clicking the next button. Repeat for each wheel.



NOTICE

During this release test, the pump may switch on repetitively.

See chapter: Testing [▶ 28]

- Click on the button "Start wizard" at the bottom right. Follow the instructions listed in the sub window in order to bleed the ABS M5 Porsche Cup Kit hydraulic unit.



NOTICE

This will bleed the ABS M5 Porsche Cup Kit hydraulic unit only, not the brake lines or the wheel brake cylinders.

See chapter: Repair Bleeding Wizard [▶ 31]

- Bleed brakes in normal fashion, starting with the furthest brake from the master cylinder and finishing with the nearest. Check errors one last time, diagnosis any errors present, then disconnect MSA-Box II from ABS M5 Porsche Cup Kit harness. Once MSA-Box II is disconnected verify that MIL lamp turns off and stays off.
- Check for proper brake operation at low speeds first. Start with map switch in a neutral position (position 5 to 7).



NOTICE

Refer to manual for more information regarding the map switch position function.

- Warning light (MIL) on for a short time when you switch on the ignition, on permanent when map switch in position 12 (OFF).

11 Legal

11.1 Legal Restrictions of Sale

The sale of this product in Mexico is prohibited.

Due to embargo restrictions, sale of this product in Russia, Belarus, Iran, Syria, and North Korea is prohibited.

12 CAN Protocol V15 customer from 0400 onwards

ABS-M5 CAN		Version 15	16.02.2018									
Customer version												
Input												
Name	ID	Start [Bit]	Length [Bit]	Byte Order	Value Type	Initial Value	Factor	Offset	Minimum	Maximum	Unit	Comment
ABS_Switchposition	0x24C	0	8	Intel	Unsigned	0	1	0	0	11		Channel to send the switch position via CAN to the ABS. Rate must be 10 ms / 100 Hz.
ABS												
Name	ID	Start [Bit]	Length [Bit]	Byte Order	Value Type	Initial Value	Factor	Offset	Minimum	Maximum	Unit	Comment
RG_VL_Bremse2	0x24A	0	16	Intel	Unsigned	0	0.015625	0	0	100	m/s	Wheel speed direct FL
RG_VR_Bremse2	0x24A	16	16	Intel	Unsigned	0	0.015625	0	0	100	m/s	Wheel speed direct FR
RG_HL_Bremse2	0x24A	32	16	Intel	Unsigned	0	0.015625	0	0	100	m/s	Wheel speed direct RL
RG_HR_Bremse2	0x24A	48	16	Intel	Unsigned	0	0.015625	0	0	100	m/s	Wheel speed direct RR
SPK_FA	0x342	0	8	Intel	Unsigned	0	0.05	0	0	10	cm3	Fill level of the fluid reservoir of the front axle.
SPK_RA	0x342	8	8	Intel	Unsigned	0	0.05	0	0	10	cm3	Fill level of the fluid reservoir of the rear axle.
WheelQuality_FL	0x342	32	8	Intel	Unsigned	0	1	0	0	32		Identification bit for wheel speed signal disturbances, check the sensor and the surrounding if bit is > 1.
WheelQuality_FR	0x342	40	8	Intel	Unsigned	0	1	0	0	32		
WheelQuality_RL	0x342	48	8	Intel	Unsigned	0	1	0	0	32		
WheelQuality_RR	0x342	56	8	Intel	Unsigned	0	1	0	0	32		
Brake_bal_at50	0x560	16	8	Intel	Unsigned	0	1	0	0	60	Bar	Calculated rear axle brake pressure if the front pressure is at 50 bar.
Brake_bal_at50_advice	0x560	24	8	Intel	Unsigned	0	1	0	0	60	Bar	Recommended rear axle brake pressure if the front pressure is at 50 bar.
Brake_bal_proc	0x560	32	8	Intel	Unsigned	0	1	0	0	100	%	Percental brake balance on the front axle.
Brake_bal_proc_advice	0x560	40	8	Intel	Unsigned	0	1	0	0	100	%	Recommended percental brake balance on the front axle.
Diag_FL	0x541	0	2	Intel	Unsigned	0	1	0	0	3		Value to show faults related to the wheel speed sensor.
Diag_FR	0x541	2	2	Intel	Unsigned	0	1	0	0	3		0 - Signal ok,
Diag_RL	0x541	4	2	Intel	Unsigned	0	1	0	0	3		1 - Wiring related fault,
Diag_RR	0x541	6	2	Intel	Unsigned	0	1	0	0	3		2 - Signal related fault
Diag_ABSUnit	0x541	8	1	Intel	Unsigned	0	1	0	0	0		Bit to show, if an ABS error related to the hydraulic unit is present
Diag_FusePump	0x541	9	1	Intel	Unsigned	0	1	0	0	0		Bit to show, if an ABS error related to the fuse or power supply of the ABS pump is present.
Diag_FuseValve	0x541	10	1	Intel	Unsigned	0	1	0	0	0		Bit to show, if an ABS error related to the fuse or power supply of the ABS valves is present.
SwitchPosition	0x5C0	0	8	Intel	Unsigned	0	1	0	1	12		Used switch position of the ABS.
P_FA	0x5C0	8	8	Intel	Unsigned	0	1	0	0	255	bar	Brake pressure on the front axle.
P_RA	0x5C0	16	8	Intel	Unsigned	0	1	0	0	255	bar	Brake pressure on the rear axle.
BLS	0x5C0	24	1	Intel	Unsigned	0	1	0	0	1		Bit for the brake light switch.
ABS_Malfunction	0x5C0	28	1	Intel	Unsigned	0	1	0	0	0		Bit will jump to 1, if the ABS control is deactivated by a fault.
ABS_Active	0x5C0	29	1	Intel	Unsigned	0	1	0	0	1		Bit will jump to 1, when the ABS control is active.

ABS												
Name	ID	Start [Bit]	Length [Bit]	Byte Order	Value Type	Initial Value	Factor	Offset	Minimum	Maximum	Unit	Comment
EBD_Lamp	0x5C0	30	1	Intel	Unsigned	0	1	0	0	1		Bit will jump to 1, when the EBD is deactivated due to a fault.
ABS_Lamp	0x5C0	31	1	Intel	Unsigned	0	1	0	0	1		Bit will jump to 1, when the ABS control is deactivated due to a fault, switched to the off position or while working with RaceABS.
AX1_Bremse60	0x5C0	32	16	Intel	Unsigned	0	0.00012742	-4.1768	-4.1768	4.17367	g	Used longitudinal acceleration value in the ABS.
AY1_Bremse60	0x5C0	48	16	Intel	Unsigned	0	0.00012742	-4.1768	-4.1768	4.1765	g	Used lateral acceleration value in the ABS.
MM5.10												
Name	ID	Start [Bit]	Length [Bit]	Byte Order	Value Type	Initial Value	Factor	Offset	Minimum	Maximum	Unit	Comment
Yaw_Rate	0x70	0	16	Intel	Unsigned	0	0.005	-163.84	-163.84	163.83	°/s	Measured yaw rate around the Z axle.
AY1	0x70	32	16	Intel	Unsigned	0	0.000127465	-4.1768	-4.1768	4.1765	g	Measured lateral acceleration.
Roll_Rate	0x80	0	16	Intel	Unsigned	0	0.005	-163.84	-163.84	163.835	°/s	Measured roll rate around the X axle.
AX1	0x80	32	16	Intel	Unsigned	0	0.000127465	-4.1768	-4.1768	4.1765	g	Measured longitudinal acceleration.
AZ	0x576	32	16	Intel	Unsigned	0	0.000127465	-4.1768	-4.1768	4.1765	g	Measured vertical acceleration.
Other IDs in use from ABS M5												
	0x140											
	0x141											
	0x142											
	0x143											
	0x340											
	0x341											
	0x343											
	0x75											

13 Drawings and Diagrams

13.1 Offer Drawing Hydraulic Unit

Urbefüllte Hydroaggregate werden mit Abdeckklebefolie (B-Typ) ausgeliefert. NOT FILLED HYDRAULIC UNITS ARE DELIVERED WITH A SIX-PIECE, ADHESIVE COVER TAPE.

Halterschnittstelle siehe Einbauhinweis siehe Einbauhinweis ACCORDING TO: Y 265 K30 183

Zulässige Einbaulage PERMISSIBLE MOUNTING POSITION

Begefüllte Hydroaggregate werden mit Schraubstopfen ausgeliefert. FILLED HYDRAULIC UNITS ARE DELIVERED WITH SCREW PLUGS.

Generelles Reparaturverbot!

- Lieferzustand:
Nicht befüllt: Nur fuer Erstausrüstung, Verwendung als Ersatzteil nicht zulässig.
Befüllt: Aggregat vollständig mit Bremsflüssigkeit gefüllt, Verwendung als Ersatzteil.

- Abdeckung fuer Bremszylinderanschlüsse erst bei Montage der Bremsleitungen entfernen.

- Anschlussgewinde:
Bremsleitungen fuer Gewindeanschlüsse nach ISO 4038 verwenden.
Empfohlenes Anzugsmoment: Mo: 14...18 Nm
Technische Freigabe von Bremsleitungen, Montageprozess und Anzugsmoment erfolgt durch Kunde.

REPAIRS NOT PERMISSIBLE!
- AS DELIVERED STATE:
NON-FILLED: FOR OEM ONLY, USE AS SERVICE PART NOT PERMISSIBLE.
FILLED: COMPLETELY FILLED WITH BRAKE FLUID, USE AS SERVICE PART.
- PORTS MUST REMAIN CLOSED UNTIL ASSEMBLY OF BRAKE LINES.

- CONNECTING PORT THREADS:
USE FITTING FOR PORT THREADS ACCORDING TO ISO 4038.
RECOMMENDED TORQUE: Mo: 14...18 Nm
TECHNICAL RELEASE OF BRAKE TUBES, ASSEMBLY PROCESS AND TORQUE VALUES TO BE DEFINED BY CUSTOMER.

Etikett (nur fuer Reprogrammierung) / LABEL (FOR REPROGRAMMING ONLY)

*2 REFERENCE / Bezug M10x1 (K-A)

*4 nach Montage / AFTER ASSEMBLY
*5 vor Montage / BEFORE ASSEMBLY

Steckverbindung 38-pol. nach Angebotszeichnung: CONNECTOR 38 PIN ACCORDING TO OFFER DRAWING I 928 A00 289

0 265 282 033	begefüllt / FILLED (SPARE PART)	F 02U V05 288-01	0 265 K30 670	0 265 282 033 ONLY FOR RACE	Diverse - DF11v variant
0 265 281 964	begefüllt / FILLED (SPARE PART)	F 02U V05 287-01	0 265 K30 648	0 265 281 964 ONLY FOR RACE	Diverse - DF11s variant
0 265 281 892	begefüllt / FILLED (SPARE PART)	F 02U V05 286-01	0 265 K30 633	0 265 281 892 ONLY FOR RACE	Diverse - DF11s variant

HZ1	Hauptzylinder Vorderachse	M12x1k	MC1	MASTER CYLINDER FRONT AXLE
VL	Radzylinder vorne links	M10x1	FL	WHEEL CYLINDER FRONT LEFT
VR	Radzylinder vorne rechts	M10x1	FR	WHEEL CYLINDER FRONT RIGHT
HZ2	Hauptzylinder Hinterachse	M12x1k	MC2	MASTER CYLINDER REAR AXLE
HL	Radzylinder hinten links	M10x1	RL	WHEEL CYLINDER REAR LEFT
HR	Radzylinder hinten rechts	M10x1	RR	WHEEL CYLINDER REAR RIGHT

DRUCKNUMMER / Druck Number	AS DELIVERED STATE / Lieferzustand	CUSTOMER PART NUMBER / Kundennummer	PROJECT ID / Projekt ID	CUSTOMER CODE / Kundenkennzeichnung	VEHICLE TYPE / Fahrzeugtyp
----------------------------	------------------------------------	-------------------------------------	-------------------------	-------------------------------------	----------------------------

0 265 444 672 000	0 265 A44 672-000	000	02
-------------------	-------------------	-----	----

13.2 Offer Drawing Wheel Speed Sensor

INSTALLATION BORE
Einbaubohrung

MATERIAL
Werkstoff

HOUSING: POLYAMIDE HEAT STABILIZED
Gehäuse: Polyamid wärme-stabilisiert

CABLE: MOLDED CABLE COVER
TWO CORES, Ø : 5,0±0,3
COVER INSULATION: POLY-URETHANE ELASTOMER 95±5 SHORE A.
Leitung: Mantelleitung zweifadrig
Aussen Ø : 5,0±0,3;
Mantelisolierung: Polyurethan-Elastomer 95±5 Shore A.

BUSHING: STEEL
Buchse: Stahl

3D VIEW
3D Ansicht
SCALE 1:1
M 1:1

VIEW A
Ansicht A

CONTACT 1: ON BLACK CORE FOR SIGNAL (-)
Kontakt 1: An schwarzer Ader fuer Signal (-)

CONTACT 2: ON WHITE CORE FOR SUPPLY VOLTAGE (+)
Kontakt 2: An weisser Ader fuer Versorgungsspannung (+)

NO REVERSE POLARITY PROTECTION!
Kein Verpolschutz!

GENERAL REMARK:
WARNING! THIS WHEEL SPEED SENSOR CONTAINS AN ELECTRONIC COMPONENT THAT CAN POTENTIALLY BE DAMAGED DUE TO ELECTROSTATIC DISCHARGE. REFER TO THE OPERATING INSTRUCTION FOR PROPER HANDLING OF ELECTROSTATICALLY SENSITIVE COMPONENTS.

Allgemeiner Hinweis:
Achtung! Dieser Drehzahlwähler enthält ein elektronisches Bauteil und kann somit potentiell durch elektrostatische Entladung beschädigt werden. Die Handhabungsvorschriften fuer elektrostatisch empfindliche Bauteile sind einzuhalten.

PERMISSIONS

Dr. Ing. h.c. F. Porsche AG	Dr. Ing. h.c. F. Porsche AG	Dr. Ing. h.c. F. Porsche AG	Dr. Ing. h.c. F. Porsche AG	Dr. Ing. h.c. F. Porsche AG	Dr. Ing. h.c. F. Porsche AG	Dr. Ing. h.c. F. Porsche AG	Dr. Ing. h.c. F. Porsche AG
0 265 002 240	0 265 008 622	DF 114K	0 265 800 817	FRONT AXLE / VA	5209	INSULATION	3S IS
DRAFT NUMBER	ORDER NUMBER	TYPE	DATA SHEET	INSULATION	EXPORT	3S IS	3S IS
Elektronische Zeichnung	Bestellnummer	2	4	5	6	7	7

AGZ 0265A02240-718 S. 01 14.09.2009 Vers. 005 NEU

BHP/DocMaster Original, neuestes Dokument am 25.02.2011

DE-GIF2SI

13.3 Offer Drawing Brake Pressure Sensor

Pin 3: Versorgung (+)
Pin 3: SUPPLY VOLTAGE (+)

Pin 2: Ausgang
Pin 2: OUTPUT

Pin 1: Masse (-)
Pin 1: GROUND (-)

Kabelbaumstecker: RB-Kompaktstecker 1.1a nach RB-Zeichnung A 928 000 453, 3-polig, Kodierung I, BDK-Kontakte vergoldet, 0.5-1.0mm²

WIRE HARNESS CONNECTOR : RB KOMPAKT CONECOR 1.1A ACC. TO RB DRAWING A 928 000 453, 3 PINS, CODING I. BDK TRMINALS GOLD-PLATED, 0.5-1.0 mm²

Werkstoff: 1.4542 (DIN Norm)
MATERIAL: 1.4542 (DIN Norm)

Am Sensor: RB-Kompaktstecker 1.1 nach RB-Zeichnung 1 928 A00 755 Variante B vom 11.05.2004 (in hochschuettelfester Ausfuehrung) 3-polig, Kodierung I, Kontakte vergoldet
Werkstoff: PBT GF30

AT SENSOR: RB KOMPAKT CONNECTOR 1.1 ACC. TO RB DRAWING 1 928 A00 755 VARIANT B FROM 11.05.2004 (IN HIGH VIBRATION RESISTANT DESIGN) 3 PINS, CODING I, TERMINALS GOLD-PLATED
MATERIAL: PBT GF30

Stanzanzug max. 0.6
STAMP PULL-IN MAX. 0.6

0.05 A

M 10 x 1-6g

Rz 10

90°

BOSCH

Herkunftsbezeichnung
MARKING OF ORIGIN
Auf der Ruckseite:
ON THE BACK:

Werknummer
NUMBER OF PLANT

Typ-Aufschrift
TYPE DESIGNATION

Fertigungsdatum und Seriennummer unverschlüsselt
DATE OF PRODUCTION AND SERIAL NUMBER NOT ENCODED

ECC 200
18x18

SW 27

1:1

1:1

Stutzen nach unten gerichtet.
Empfohlene Lage: 0...90°
in allen Richtungen zur Senkrechten.
ORIFICE DIRECTED DOWNWARDS.
RECOMMENDED POSITION: 0...90°
FROM VERTICAL.

Wichtige Hinweise:

- RB-Gewahrleistung fuer die Funktion des Stecksystems nur bei Verwendung der in dieser Angebotszeichnung vorgeschriebenen Gegenstecker-Systemteile.
- Erste Abstuetzstelle des Kabels max. 150mm nach der Steckverbindung (gestreckte Kabellaenge). Sie muss auf dem Sensortraeger liegen.
- Abwicklung des Kabels (Abweichung von der geraden Linie) zwischen Kabelabgang am Sensor und erster Abstuetzstelle: 20...90°
- Zulaessiger Biegeradius des Kabels bis zur ersten Abstuetzstelle: R ≥ 50mm
- Einbauvorschrift siehe zugehoerige Railangebotszeichnung bzw. Rail-TKU
- Max. zulaessige Einschraubbelastung: 35Nm
- Montagehinweis siehe Y 261 F26 048

Zu beachten: Sensor ist durch aufgesteckten Gegenstecker vor Eindringen von Wasser zu schuetzen.

IMPORTANT NOTES

- RB WARRANTY WILL COVER THE FUNCTION OF THE CONNECTOR SYSTEM ONLY IN CASE OF COMBINATION WITH HARNESS CONNECTOR SYSTEM PARTS ACCORDING TO THIS OFFER DRAWING.
- FIRST CABLE MOUNTING POINT MAX. 150 MM AFTER THE PLUG (STRAIGHT CABLE LENGTH). IT MUST BE LOCATED ON THE SENSOR CARRIER.
- ANGLE OF BENDING THE CABLE (DEVIATION FROM STRAIGHT LINE) BETWEEN CABLE EXIT AT SENSOR AND FIRST MOUNTING POINT: 20...90°.
- ADMISSIBLE BENDING RADIUS OF THE CABLE UP TO THE FIRST CABLE MOUNTING POINT: R ≥ 50MM.
- INSTALLATION INSTRUCTIONS SEE CORRESPONDING OFFER DRAWING RAIL RESPECTIVELY TKU RAIL
- MAX. AUTHORIZED STRESS TO SCREW IN: 35Nm
- ASSEMBLY INSTRUCTIONS SEE Y 61 F26 048

ATTENTION: USE HARNESS CONNECTOR FOR PROTECTION AGAINST WATER INGRESS.

Obwohl Bosch keine Haftung fuer die Richtigkeit der Angaben, auch hinsichtlich der Eignung fuer bestimmte Anwendungen, annimmt, wird die Haftung fuer die Richtigkeit der Angaben nicht ausgeschlossen.

0 261 B04 407 Draft drawing number Entwurfs-Zeichnung	0 261 545 040 Order number Bestell-Nummer	0 261 545 040 Type Typ	0 261 K00 109-000 Data sheet (TKU) DATA SHEET
---	---	------------------------------	---

02 28EH9331B	20111122	Hi	Sw	Sv	2130	GS-SI/ENS		
01 0261545040	20071220	De	Kr		2130	GS-SI/ENS		
00 initial	20051214	De					null	Migration-ORG: Orig: GS-SI/ENS
Ind.	Change/And.	YYYYMMDD	Drawn/Bez.	Checked/Sepr.	Released/Freig.	SWN	Resp. dept./Verantw. Abt.	Addr. info./Zus. Info.
Lang./Spr.	Ug	35.3 g						
HIGH PRESSURE SENSOR			DS-HD-K14.2 28bar			Sheet/Bl.		
HOCHDRUCKSENSOR			DS-HD-K14.2 28bar			1 / 1		
Scale/Mastab		2:1	Doc. type		AGZ	0 261 A04 407		DP/ID
MNR			Repl. for			Repl. by		001 02 A2

13.4 Mounting Instructions Brake Pressure Sensor

Bosch Gasoline Systems, P81 | 2703373053 DRW 001 03 | SAP-Status 40 | Labor F28 | Change F030GD000901

4 = Prozessregelung (SPC) nach gueltigen Regeln mit cpk-Nachweis/ SPC ACCORDING TO APPLICABLE STANDARDS WITH cpk-RECORD

keine Gratwurzel auf Flaeche $\varnothing 25.4$ zulaessig
NO HIP HEAD ON $\varnothing 25.4$ ALLOWED

Gratwurzel in radialer Richtung von 0.1 zulaessig
0.1 HIP HEAD IN RADIAL DIRECTION ALLOWED

Rz max 25

keine Beschädigungen (Kerben, Druckstellen) im Dichtbereich zulaessig
NO DAMAGES (SCORES, PRESSURE-MARKS) WITHIN THE SEALING-AREA PERMISSIBLE

gekennzeichnete Bereich beachten:
 $\varnothing 3.2$, 120° -, 90° Konus, Gewinde- und Gewindekern muessen in einer Aufspannung hergestellt werden

MARKED AREA:
 $\varnothing 3.2$, 120° -, 90° CONE, THREAD AND THREAD CORE MUST BE MACHINED IN ONE SETTING

Frei von Öl, Fett und Rückständen
FREE OF OIL, GREASE AND RESIDUALS

Waehrend Lagerung und Transport vor Verschmutzung schuetzen
SAVE AGAINST CONTAMINATION DURING STORAGE AND TRANSPORTATION

ISO-Grenzmasse/ ISO LIM. OF SIZE	Toleranzklasse/ TOL. CLASS	Grenzabweichung/ LIM. DEVIATIONS
über bis		
OVER TO		

2 703 373 053

Rauheitsang. +DIN EN ISO 1302 (NI2A D53/1) SURF. ROUGHN.

Kanten +DIN ISO 13715 (NI2A B42) EDGES

Metr. ISO ohne Oberfl. mit Oberfl. W/O SURFACE WITH SURFACE

Aussengewinde EXT. THREAD

Innengewinde INT. THREAD

Nicht tolerierte Masse
NON TOLERANCED DIMENSIONS

0,5	> 3	> 6	> 30	> 120	> 400
...3	...6	...30	...120	...400	...1000
$\pm 0,1$	$\pm 0,1$	$\pm 0,2$	$\pm 0,3$	$\pm 0,5$	$\pm 0,8$

Rundungen, Fosen
RADII, CHAMFERS

$\pm 0,2$	$\pm 0,5$	± 1	± 1	± 1	± 1
-----------	-----------	---------	---------	---------	---------

Winkel, Masse der kuerzeren Schenkel
ANGLES, DIM. OF THE SHORTER SIDE

bis 10	> 10	> 50	> 120	> 400
...3	...6	...30	...120	...400
$\pm 1^\circ$	$\pm 30^\circ$	$\pm 20^\circ$	$\pm 10^\circ$	$\pm 5^\circ$

Form- und Lagertoleranzen
TOLERANCES OF FORM AND POSITION
DIN ISO 2768-H (NI3 B92/1)

Stoffe entsprechen N2580
MATERIALS CORRESPOND TO N2580

1:1

Fehl. Angaben/ MISS. DETAILS		Oberflaeche SURFACE		Massstab SCALE 2:1 (5:1 1:1)		Gewicht WEIGHT	
1. Verwendung/ 1ST APPLICAT.				Stoff/MAT'L			
Dokumententyp/ DOCUMENT TYPE DRW				aus/ FROM siehe Stueckliste			
Stueckliste besonderes Blatt/ PARTS LIST ON SEPARATE SHEET				Benennung/ TITLE			
		Datum/ DATE 04.06.2007		Name/ NAME WR			
		VOLUME		Original: NuPI/TEF610			
03 F030GD0009		WR 17.10.2008		WR			
02 2709NW0550		WR 28.03.2008		WR			
01 0261555050F		WR 04.06.2007		WR			
Aenderung CHANGE		gez. DWN.		gueltig VALID		gepr. CHK.	
NO							

Ausdrucke und Kopien unterliegen nicht dem Änderungsdienst

Ausgedruckt am 13.02.2009 von ole2fe

13.5 Offer Drawing Yaw/Acceleration Sensor 500 kbaud

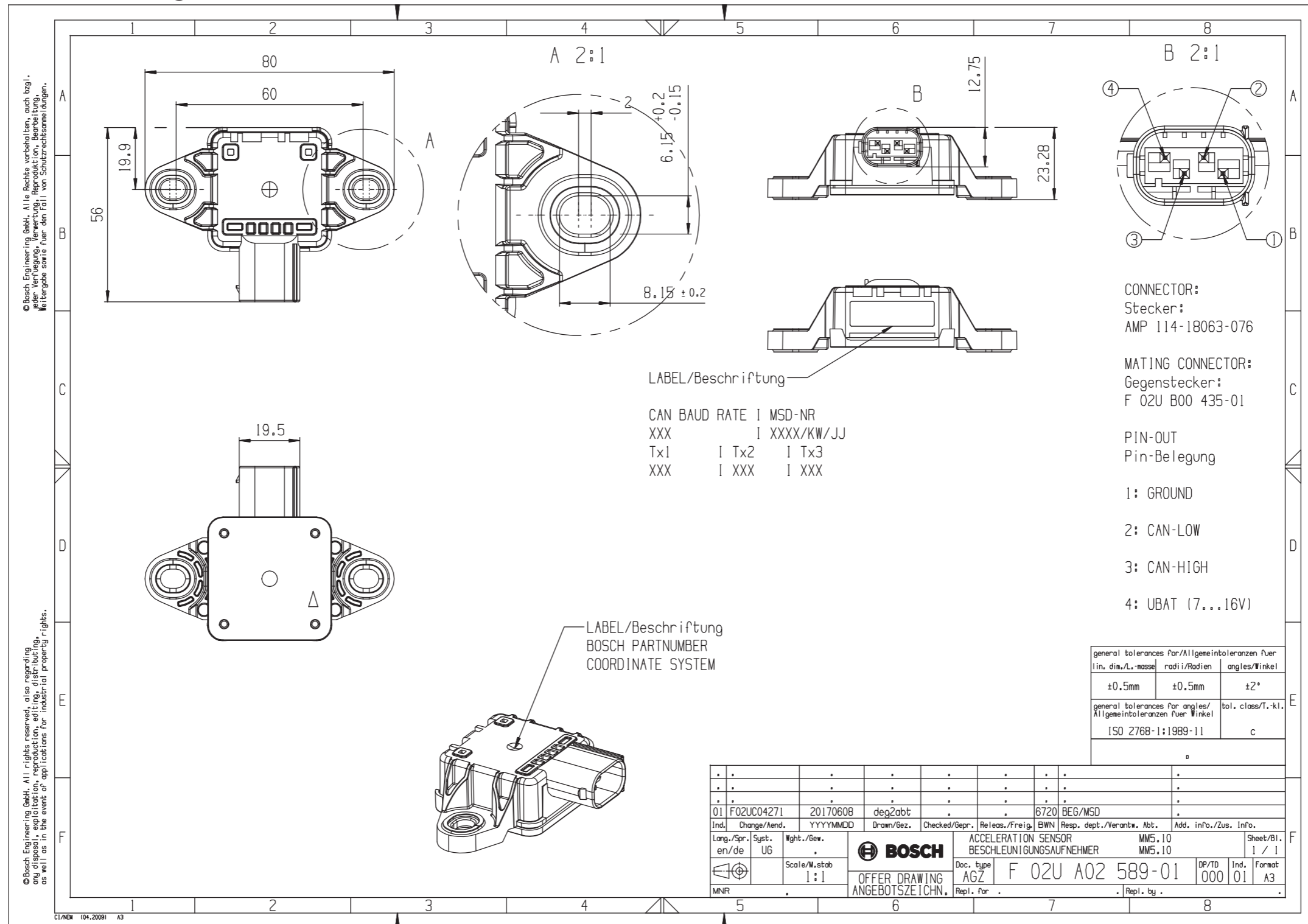

13.6 Offer Drawing Yaw/Acceleration Sensor 1 Mbaud

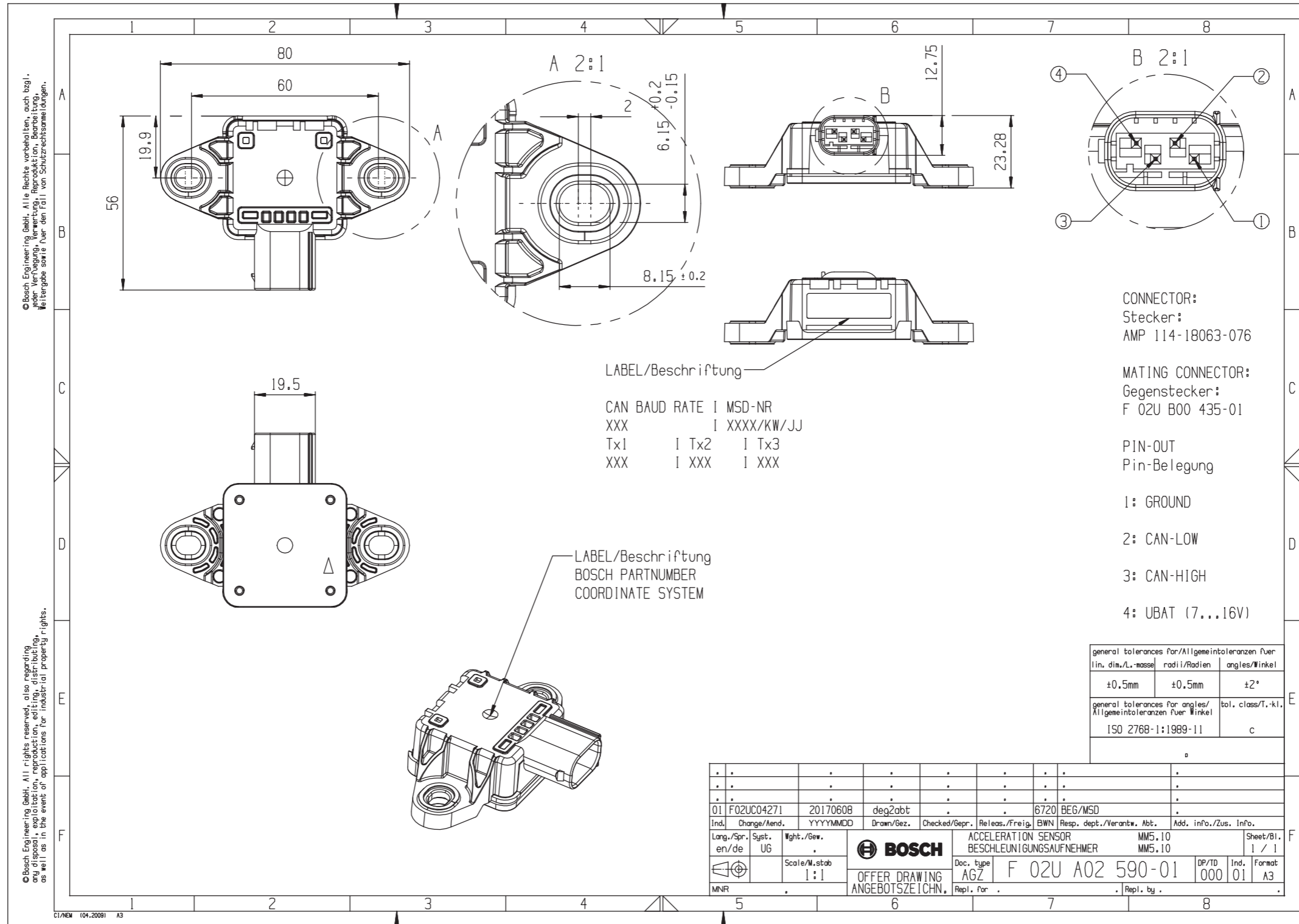

13.7 Wiring Harness Porsche 991 Gen.1

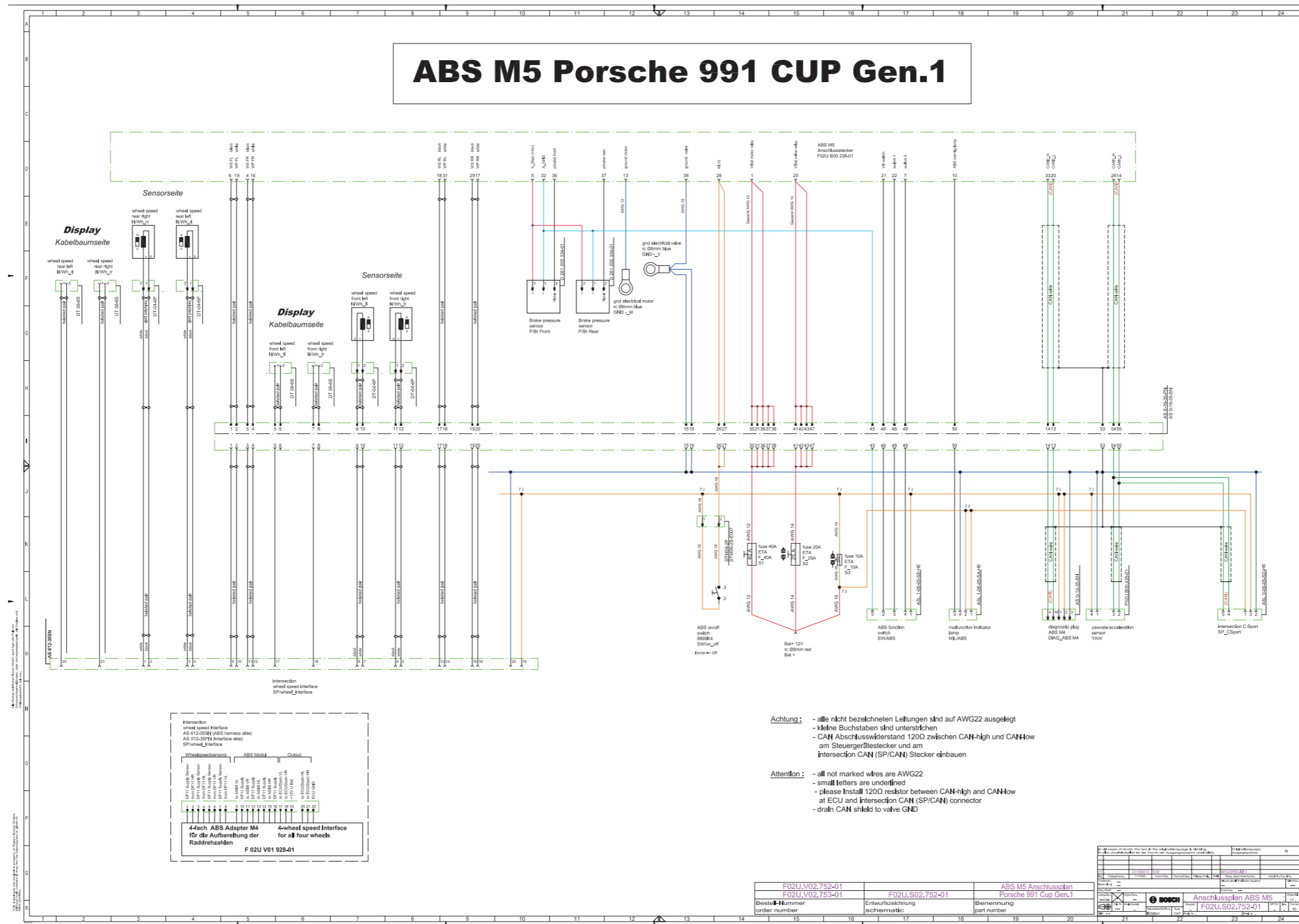

13.8 Wiring Harness Porsche 991 Gen.1 Front

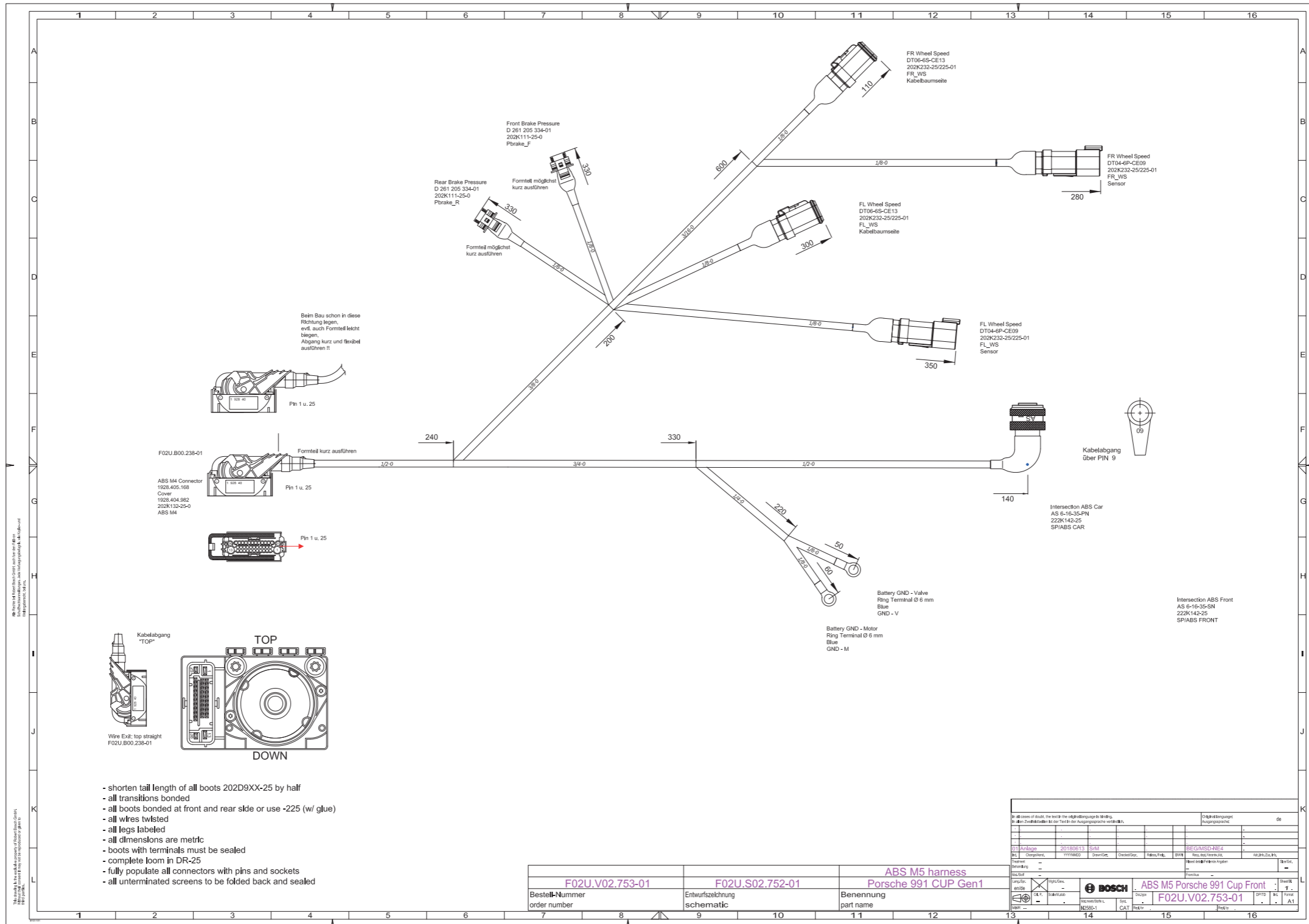

13.9 Wiring Harness Porsche 991 Gen.1 Rear

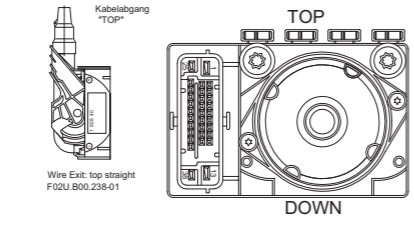
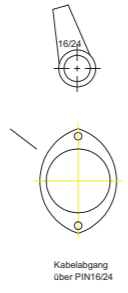
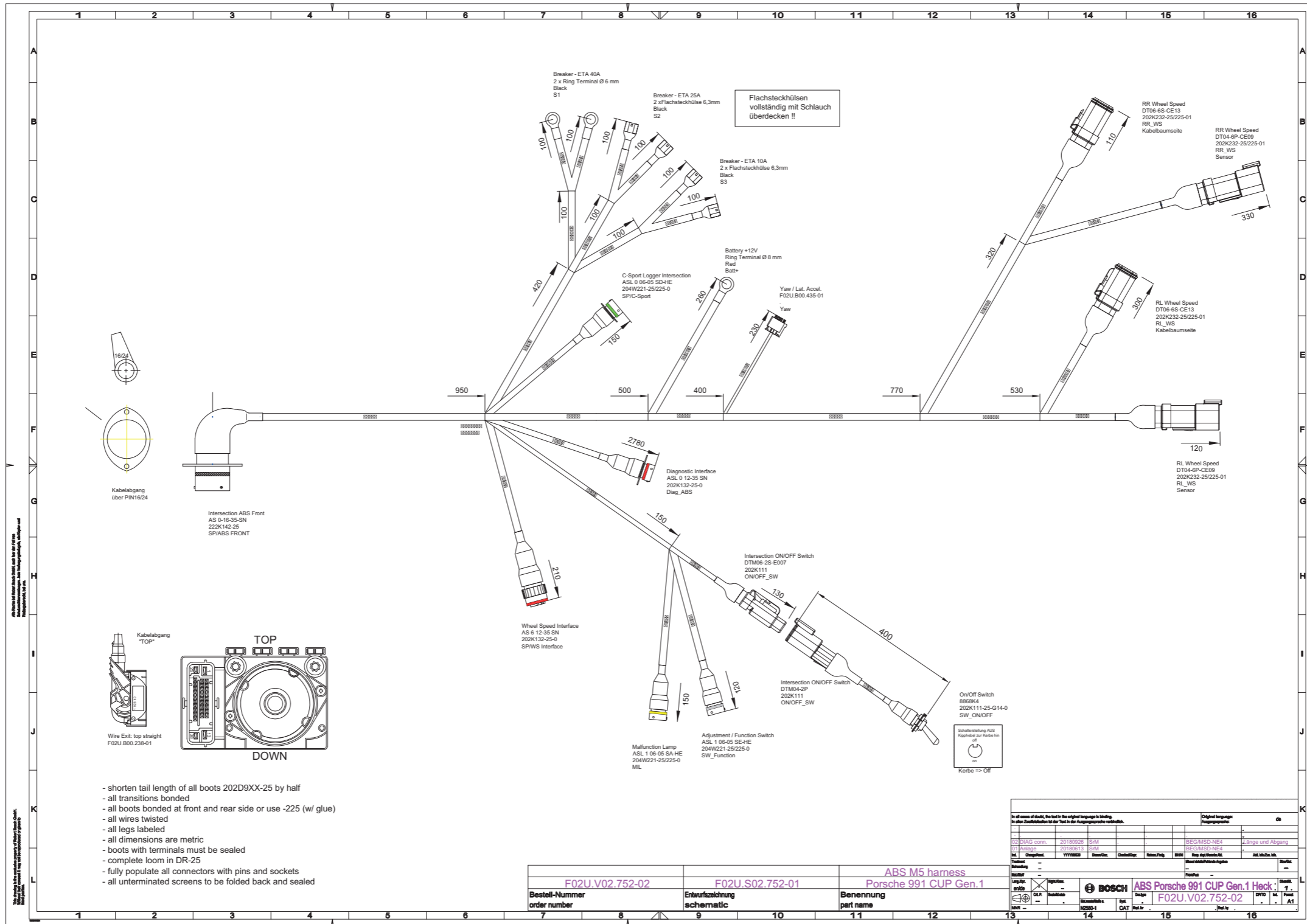

- shorten tail length of all boots 202D9XX-25 by half
- all transitions bonded
- all boots bonded at front and rear side or use -225 (w/ glue)
- all wires twisted
- all legs labeled
- all dimensions are metric
- boots with terminals must be sealed
- complete loom in DR-25
- fully populate all connectors with pins and sockets
- all unterminated screens to be folded back and sealed

F02U.V02.752-02	F02U.S02.752-01	ABS M5 harness Porsche 991 CUP Gen.1
Bestell-Nummer order number	Entwurfszeichnung schematic	Benennung part name

In all areas of doubt, the text in the original language is binding. In allen Zweifelsfällen hat die Text in der Ausgangssprache Vorrang.					Original language Ausgangssprache
202D9XX-25	20180025	SH		BEGM5D-NER	Zänge und Abgang
20180013		SH		BEGM5D-NER	
20180013		SH		BEGM5D-NER	
20180013		SH		BEGM5D-NER	

13.10 Wiring Harness Porsche 991 Gen.2

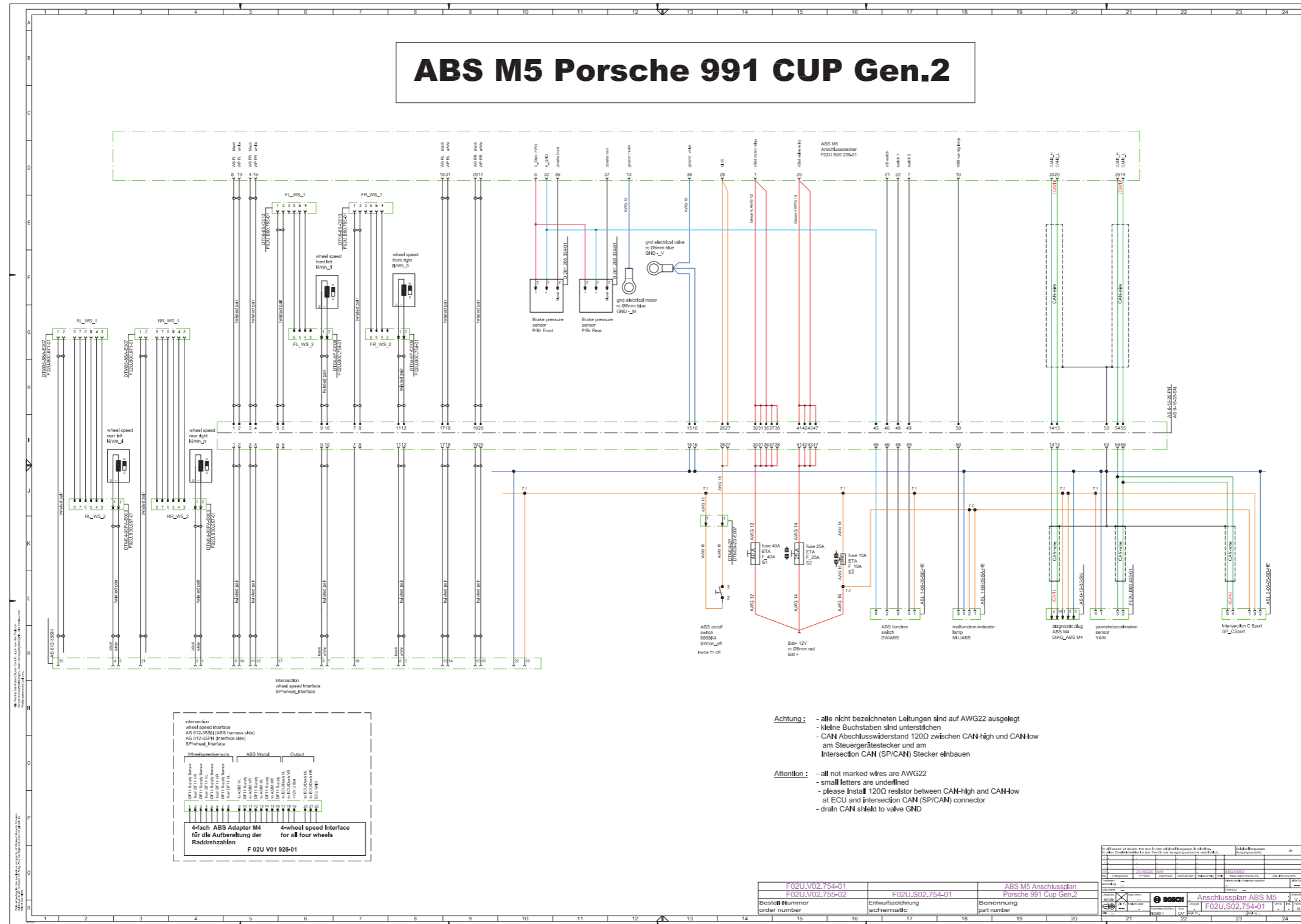

13.11 Wiring Harness Porsche 991 Gen.2 Front

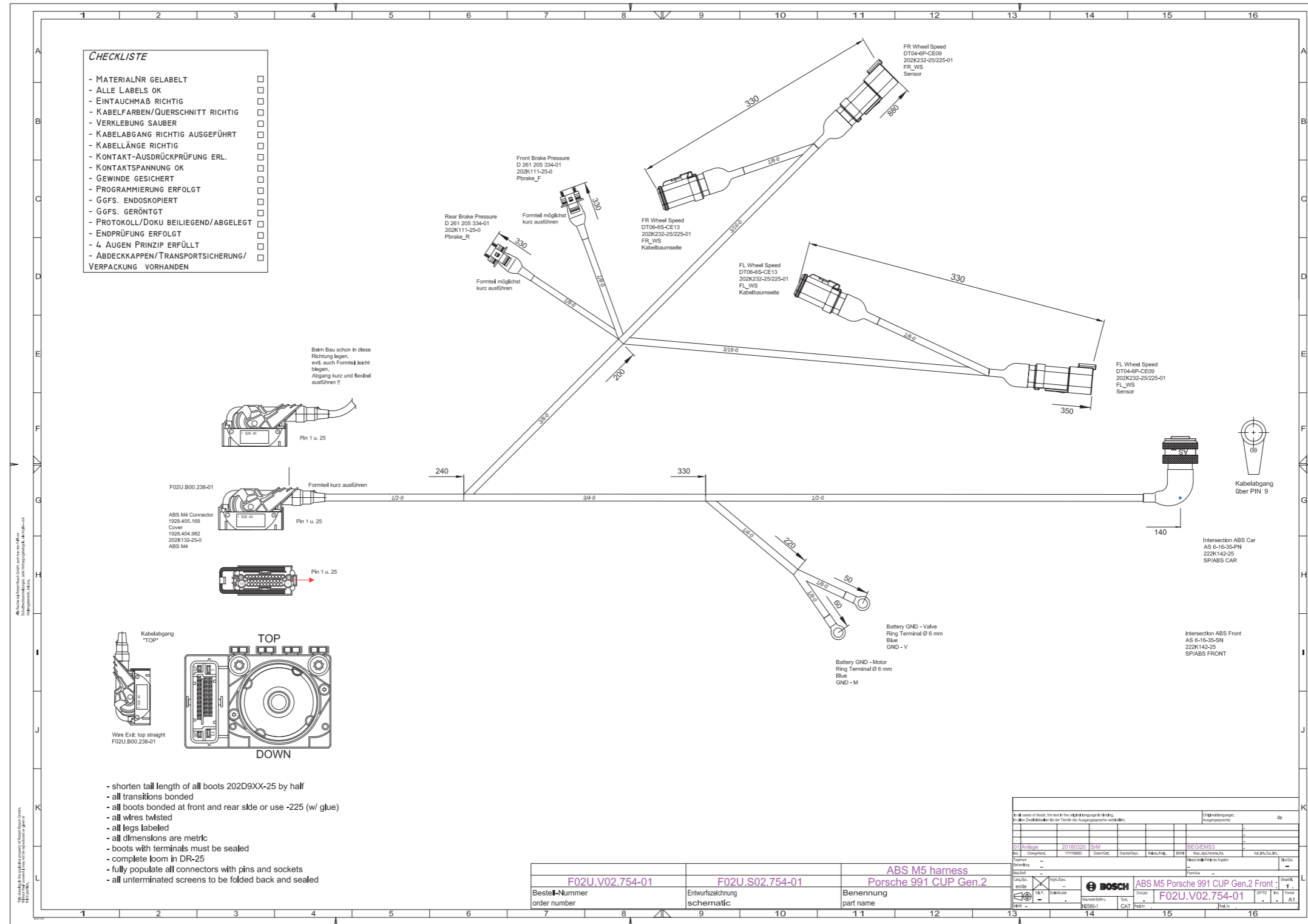

13.12 Wiring Harness Porsche 991 Gen.2 Rear

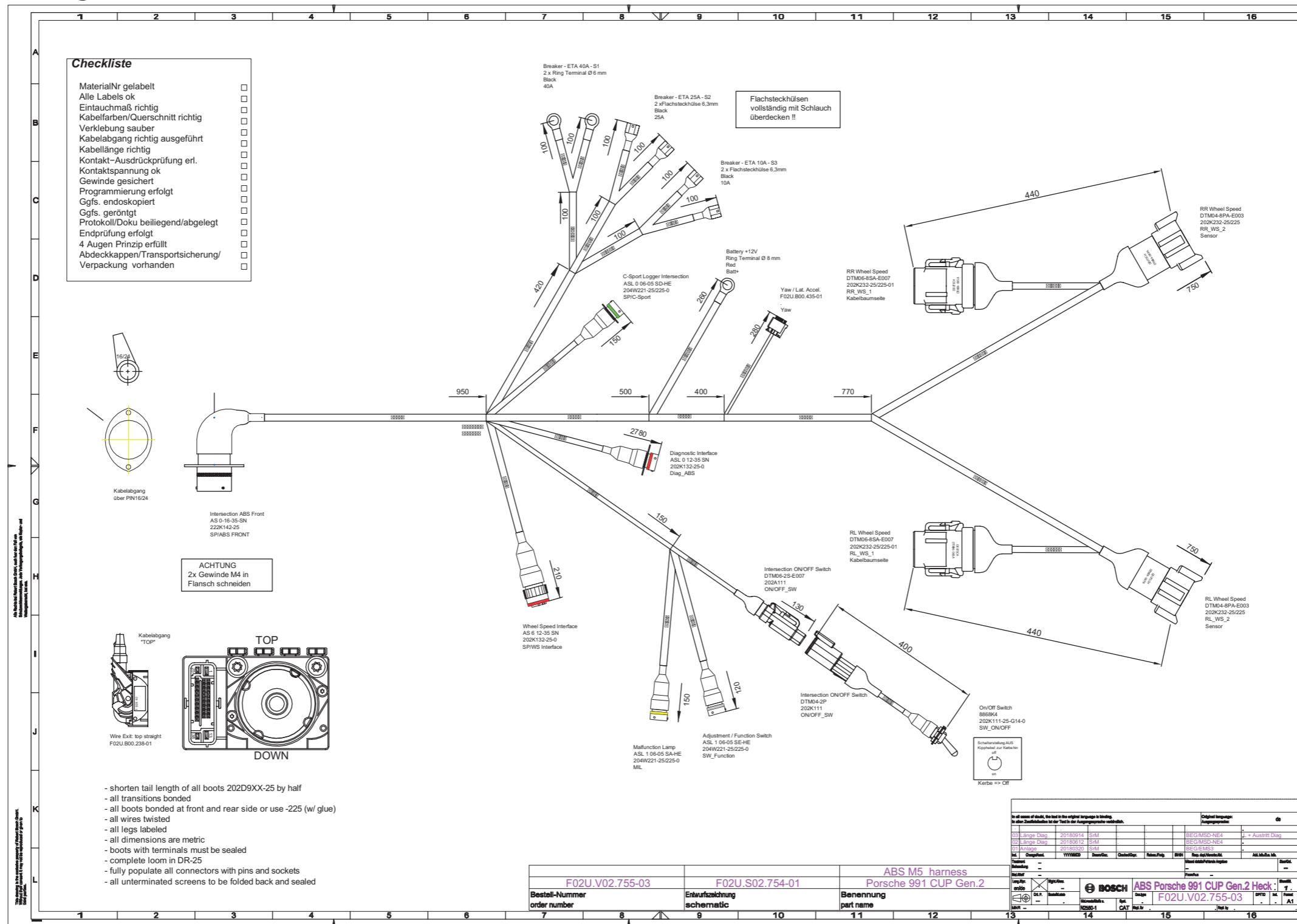

Bosch Engineering GmbH

Motorsport
Robert-Bosch-Allee 1
74232 Abstatt

www.bosch-motorsport.com